

GK10PI60B2FH

IGBT Module

Features:

- Short Circuit Rated > 10 μ s
- Low Saturation Voltage: $V_{CE(sat)} = 1.80V @ I_C = 10A, T_C = 25^\circ C$
- Low Switching Loss
- 100% RBSOA Tested ($2 \times I_C$)
- Low Stray Inductance
- Lead Free, Compliant with RoHS Requirement

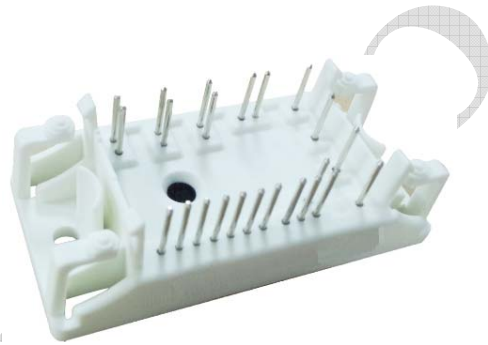

Applications:

- Industrial Inverters
- Servo Applications

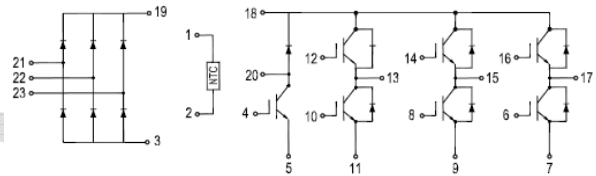

IGBT, Inverter

Maximum Rated Values ($T_C = 25^\circ C$ unless otherwise specified)

V_{CES}	Collector-Emitter Blocking Voltage		600	V
V_{GES}	Gate-Emitter Voltage		± 20	V
I_C	Continuous Collector Current	$T_C = 80^\circ C,$	10	A
		$T_C = 25^\circ C$	20	A
I_{CM}	Repetitive Peak Collector Current	$T_J = 150^\circ C$	20	A
t_{SC}	Short Circuit Withstand Time		>10	μs
P_D	Maximum Power Dissipation per IGBT	$T_C = 25^\circ C$ $T_{Jmax} = 150^\circ C$	110	W

Electrical Characteristics of IGBT ($T_C=25^{\circ}\text{C}$ unless otherwise specified)

Static characteristics

Symbol	Description	Conditions	Min	Typ	Max	Unit
$V_{GE(th)}$	Gate-Emitter Threshold Voltage	$I_C = 1 \text{ mA}, V_{CE} = V_{GE}$	4.0	4.5	5.0	V
$V_{CE(sat)}$	Collector-Emitter Saturation Voltage	$I_C = 10 \text{ A}, V_{GE} = 15 \text{ V}$	$T_J = 25^{\circ}\text{C}$	1.80	2.00	V
			$T_J = 125^{\circ}\text{C}$	2.00		V
I_{CES}	Collector-Emitter Leakage Current	$V_{GE} = 0 \text{ V}, V_{CE} = V_{CES}, T_J = 25^{\circ}\text{C}$			1	mA
I_{GES}	Gate-Emitter Leakage Current	$V_{GE} = \pm 20 \text{ V}, V_{CE} = 0 \text{ V}, T_J = 25^{\circ}\text{C}$			200	nA
C_{ies}	Input Capacitance	$V_{CE} = 25 \text{ V}, V_{GE} = 0 \text{ V}, f = 1 \text{ MHz}$		0.62		nF
C_{oes}	Output Capacitance			0.06		nF

Switching Characteristics

$t_{d(on)}$	Turn-on Delay Time	$V_{CC} = 300 \text{ V}, I_C = 10 \text{ A}, R_G = 47 \Omega, V_{GE} = \pm 15 \text{ V}, \text{ Inductive Load}$	$T_J = 25^{\circ}\text{C}$	30		ns
			$T_J = 125^{\circ}\text{C}$	30		
t_r	Rise Time		$T_J = 25^{\circ}\text{C}$	20		ns
			$T_J = 125^{\circ}\text{C}$	20		
$t_{d(off)}$	Turn-off Delay Time		$T_J = 25^{\circ}\text{C}$	230		ns
			$T_J = 125^{\circ}\text{C}$	250		
t_f	Fall Time		$T_J = 25^{\circ}\text{C}$	25		ns
			$T_J = 125^{\circ}\text{C}$	30		
E_{on}	Turn-on Switching Loss		$T_J = 25^{\circ}\text{C}$	0.14		mJ
			$T_J = 125^{\circ}\text{C}$	0.17		
E_{off}	Turn-off Switching Loss	$T_J = 25^{\circ}\text{C}$	0.20		mJ	
		$T_J = 125^{\circ}\text{C}$	0.25			
Q_g	Total Gate Charge	$T_J = 25^{\circ}\text{C}$	38		nC	
RBSOA	Reverse Bias Safe Operation Area	$I_C=20\text{A}, V_{CC}=480\text{V}, V_p=600\text{V}, R_g = 47\Omega, V_{GE}=\pm 15\text{V to } 0\text{V}, T_J = 150^{\circ}\text{C}$	Trapezoid			
SCSOA	Short Circuit Safe Operation Area	$V_{CC} = 300 \text{ V}, V_{GE} = 15 \text{ V}, T_J = 150^{\circ}\text{C}$	10			μs
$R_{\theta JC}$	IGBT Thermal Resistance: Junction-To-Case			1.149		$^{\circ}\text{C/W}$

Diode, Inverter

Maximum Rated Values ($T_C=25^\circ\text{C}$ unless otherwise specified)

V_{RRM}	Repetitive Peak Reverse Voltage	600	V
I_F	Diode Continuous Forward Current	10	A
I_{FM}	Diode Maximum Forward Current	20	A

Electrical Characteristics of FWD ($T_C=25^\circ\text{C}$ unless otherwise specified)

Symbol	Description	Conditions		Min	Typ	Max	Unit
V_{FM}	Forward Voltage	$I_F = 10\text{ A}$	$T_J = 25^\circ\text{C}$		1.40		V
			$T_J = 125^\circ\text{C}$		1.40		
I_{rr}	Peak Reverse Recovery Current		$T_J = 25^\circ\text{C}$		10		A
			$T_J = 125^\circ\text{C}$		15		
Q_{rr}	Reverse Recovery Charge	$I_F=10\text{A},$ $di/dt = 800\text{A}/\mu\text{s},$ $V_{rr} = 300\text{V},$ $V_{GE} = -15\text{V}$	$T_J = 25^\circ\text{C}$		0.5		μC
			$T_J = 125^\circ\text{C}$		0.9		
E_{rec}	Reverse Recovery Energy		$T_J = 25^\circ\text{C}$		0.04		mJ
			$T_J = 125^\circ\text{C}$		0.09		
$R_{\theta JC}$	Diode Thermal Resistance: Junction-To-Case				2.316		$^\circ\text{C}/\text{W}$

IGBT, Brake-Chopper

Maximum Rated Values ($T_C=25^\circ\text{C}$ unless otherwise specified)

V_{CES}	Collector-Emitter Blocking Voltage		600	V
V_{GES}	Gate-Emitter Voltage		± 20	V
I_C	Continuous Collector Current	$T_C = 80^\circ\text{C},$	10	A
		$T_C = 25^\circ\text{C}$	20	A
I_{CM}	Repetitive Peak Collector Current	$T_J = 150^\circ\text{C}$	20	A
t_{sc}	Short Circuit Withstand Time		>10	μs
P_D	Maximum Power Dissipation per IGBT	$T_C = 25^\circ\text{C}$ $T_{Jmax}=150^\circ\text{C}$	110	W

Electrical Characteristics of IGBT ($T_C=25^\circ\text{C}$ unless otherwise specified)

Static characteristics

Symbol	Description	Conditions	Min	Typ	Max	Unit
$V_{GE(th)}$	Gate-Emitter Threshold Voltage	$I_C = 1 \text{ mA}, V_{CE} = V_{GE}$	4.0	4.5	5.0	V
$V_{CE(sat)}$	Collector-Emitter Saturation Voltage	$I_C = 10 \text{ A}, V_{GE} = 15 \text{ V}$	$T_J = 25^\circ\text{C}$	1.80	2.00	V
			$T_J = 125^\circ\text{C}$	2.00		V
I_{CES}	Collector-Emitter Leakage Current	$V_{GE} = 0 \text{ V}, V_{CE} = V_{CES}, T_J = 25^\circ\text{C}$			1	mA
I_{GES}	Gate-Emitter Leakage Current	$V_{GE} = \pm 20 \text{ V}, V_{CE} = 0 \text{ V}, T_J = 25^\circ\text{C}$			200	nA
C_{ies}	Input Capacitance	$V_{CE} = 25 \text{ V}, V_{GE} = 0 \text{ V}, f = 1 \text{ MHz}$		0.62		nF
C_{oes}	Output Capacitance			0.06		nF

Switching Characteristics

$t_{d(on)}$	Turn-on Delay Time	$V_{CC} = 300 \text{ V}, I_C = 10 \text{ A}, R_G = 47 \Omega, V_{GE} = \pm 15 \text{ V},$ Inductive Load	$T_J = 25^\circ\text{C}$	30		ns
			$T_J = 125^\circ\text{C}$	30		
t_r	Rise Time		$T_J = 25^\circ\text{C}$	20		ns
			$T_J = 125^\circ\text{C}$	20		
$t_{d(off)}$	Turn-off Delay Time		$T_J = 25^\circ\text{C}$	230		ns
			$T_J = 125^\circ\text{C}$	250		
t_f	Fall Time		$T_J = 25^\circ\text{C}$	25		ns
			$T_J = 125^\circ\text{C}$	30		
E_{on}	Turn-on Switching Loss		$T_J = 25^\circ\text{C}$	0.14		mJ
			$T_J = 125^\circ\text{C}$	0.17		
E_{off}	Turn-off Switching Loss	$T_J = 25^\circ\text{C}$	0.20		mJ	
		$T_J = 125^\circ\text{C}$	0.25			
Q_g	Total Gate Charge	$T_J = 25^\circ\text{C}$	38		nC	
RBSOA	Reverse Bias Safe Operation Area	$I_C=20\text{A}, V_{CC}=480\text{V}, V_p=600\text{V}, R_g = 47\Omega, V_{GE}=\pm 15\text{V to } 0\text{V}, T_J = 150^\circ\text{C}$	Trapezoid			
SCSOA	Short Circuit Safe Operation Area	$V_{CC} = 300 \text{ V}, V_{GE} = 15 \text{ V}, T_J = 150^\circ\text{C}$	10			μs
$R_{\theta JC}$	IGBT Thermal Resistance: Junction-To-Case			1.149		$^\circ\text{C/W}$

Diode, Brake-Chopper
Maximum Rated Values ($T_C=25^\circ\text{C}$ unless otherwise specified)

V_{RRM}	Repetitive Peak Reverse Voltage	600	V
I_F	Diode Continuous Forward Current	10	A
I_{FM}	Diode Maximum Forward Current	20	A

Electrical Characteristics of FWD ($T_C=25^\circ\text{C}$ unless otherwise specified)

Symbol	Description	Conditions	Min	Typ	Max	Unit
V_{FM}	Forward Voltage	$I_F = 10\text{ A}$	$T_J = 25^\circ\text{C}$	1.40		V
			$T_J = 125^\circ\text{C}$	1.40		
I_{rr}	Peak Reverse Recovery Current		$T_J = 25^\circ\text{C}$	10		A
			$T_J = 125^\circ\text{C}$	15		
Q_{rr}	Reverse Recovery Charge	$I_F=10\text{A},$ $di/dt = 800\text{A}/\mu\text{s},$ $V_{rr} = 300\text{V},$ $V_{GE} = -15\text{V}$	$T_J = 25^\circ\text{C}$	0.5		μC
			$T_J = 125^\circ\text{C}$	0.9		
E_{rec}	Reverse Recovery Energy		$T_J = 25^\circ\text{C}$	0.04		mJ
			$T_J = 125^\circ\text{C}$	0.09		
$R_{\theta JC}$	Diode Thermal Resistance: Junction-To-Case			2.316		$^\circ\text{C}/\text{W}$

Diode, Rectifier ($T_C=25^\circ\text{C}$ unless otherwise specified)

V_{RRM}	Repetitive Peak Reverse Voltage	$T_J = 25^\circ\text{C}$	1600	V
I_{FRMSM}	Maximum RMS Forward Current per Chip	$T_J = 80^\circ\text{C}$	20	A
I_{RMSM}	Maximum RMS Current at Rectifier Output	$T_J = 80^\circ\text{C}$	30	A
I_{FSM}	Surge Current @ $t_p=10\text{ ms}$	$T_J = 25^\circ\text{C}$	300	A
		$T_J = 150^\circ\text{C}$	250	
I^2t	I^2t - value	$T_J = 25^\circ\text{C}$	450	A^2s
		$T_J = 150^\circ\text{C}$	300	

Electrical Characteristics of Diode ($T_C=25^\circ\text{C}$ unless otherwise specified)

Symbol	Description	Conditions		Min	Typ	Max	Unit
V_F	Forward voltage	$I_F = 10 \text{ A}$	$T_J = 25^\circ\text{C}$		1.10		V
			$T_J = 150^\circ\text{C}$		1.00		
I_R	Reverse current	$V_R = 1200\text{V}$	$T_J = 25^\circ\text{C}$			1	mA
$R_{\theta JC}$	Diode Thermal Resistance: Junction-To-Case				0.870		$^\circ\text{C}/\text{W}$

Internal NTC-Thermistor Characteristic

R_{25}	$T_C = 25^\circ\text{C}$	22.7		k Ω
$\Delta R/R$	$T_C = 100^\circ\text{C}$, $R_{100} = 1481 \text{ K}\Omega$		± 3	%
P_{25}	$T_C = 25^\circ\text{C}$	200		mW
$B_{25/50}$	$R_2 = R_{25} \exp[B_{25/50}(1/T_2 - 1/(298.15\text{K}))]$	3950		K
$B_{25/80}$	$R_2 = R_{25} \exp[B_{25/80}(1/T_2 - 1/(298.15\text{K}))]$	4000		K

Module

Symbol	Description		Min	Typ	Max	Unit
V_{iso}	Isolation Voltage (All Terminals Shorted)	$f = 50\text{Hz}$, 1minute	2500			V
T_J	Maximum Junction Temperature				150	$^\circ\text{C}$
T_{JOP}	Maximum Operating Junction Temperature Range		-40		+150	$^\circ\text{C}$
T_{stg}	Storage Temperature		-40		+125	$^\circ\text{C}$
$R_{\theta CS}$	Case-To-Sink Thermally (Conductive Grease Applied)			0.1		$^\circ\text{C}/\text{W}$
T	Mounting Screw:M4		1.0		1.5	N·m
G	Weight			23		g

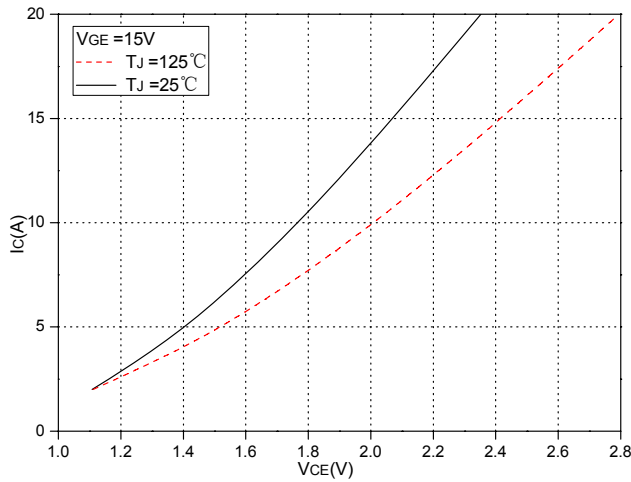

Fig.1 Typical Saturation Voltage Characteristics (Inverter)

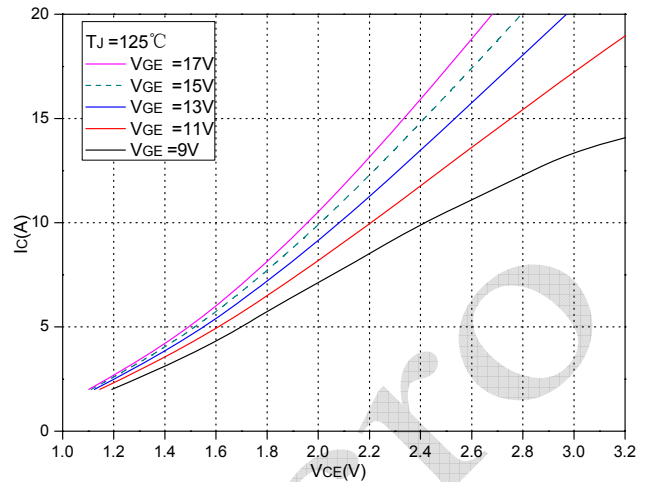

Fig.2 Typical Output Characteristics (Inverter)

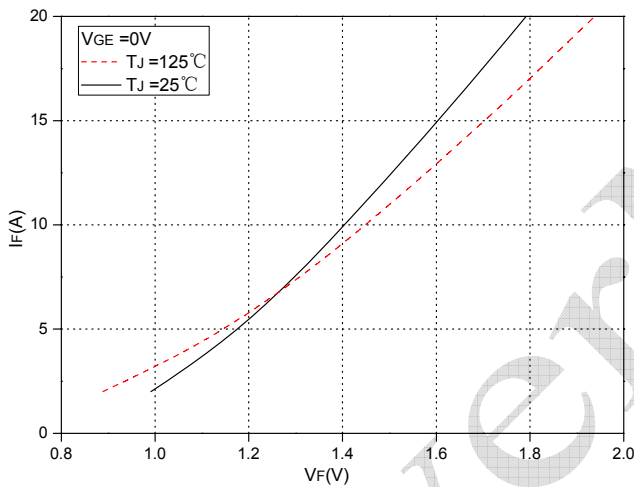

Fig.3 Forward Characteristics of FWD (Inverter)

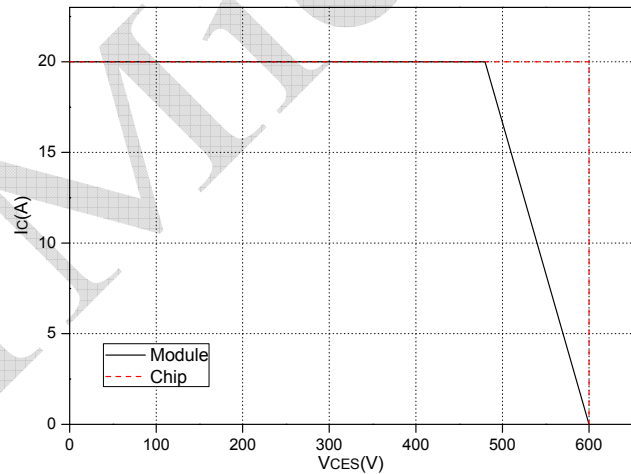

Fig.4 Reverse Bias Safe Operation Area (RBSOA)

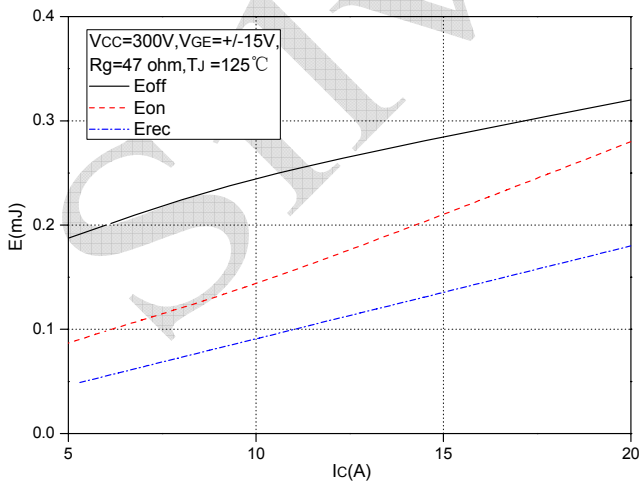

Fig.5 Typical Switching Loss vs. Collector Current (Inverter)

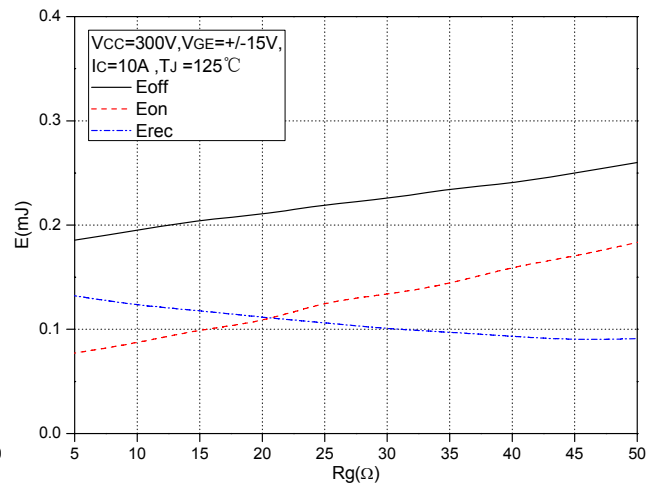

Fig.6 Typical Switching Loss vs. Gate Resistance (Inverter)

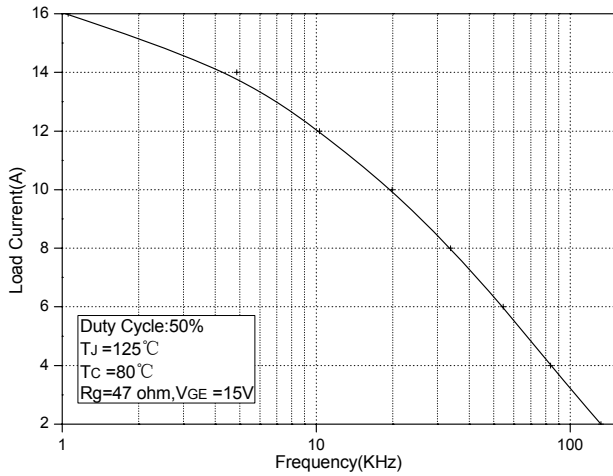

Fig.7 Typical Load Current vs. Frequency (Inverter)

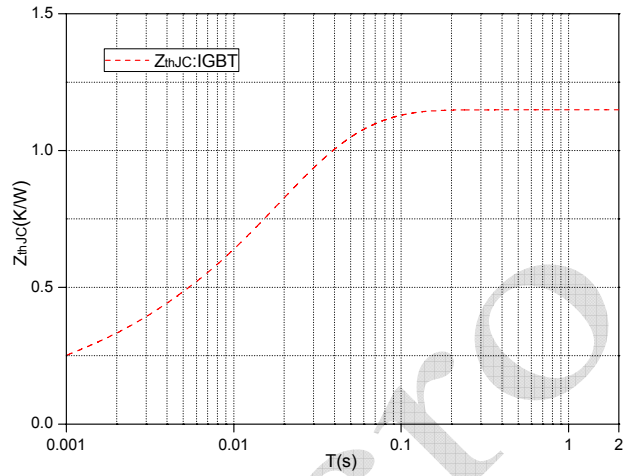

Fig.8 Transient Thermal Impedance IGBT (Inverter)

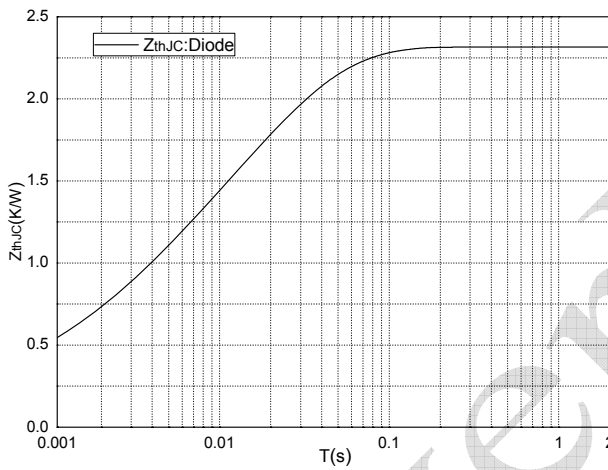

Fig.9 Transient Thermal Impedance Diode (Inverter)

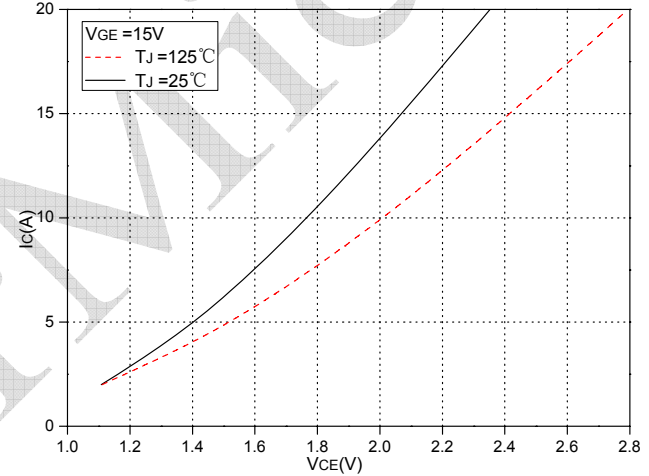

Fig.10 Typical Saturation Voltage Characteristics (Brake-Chopper)

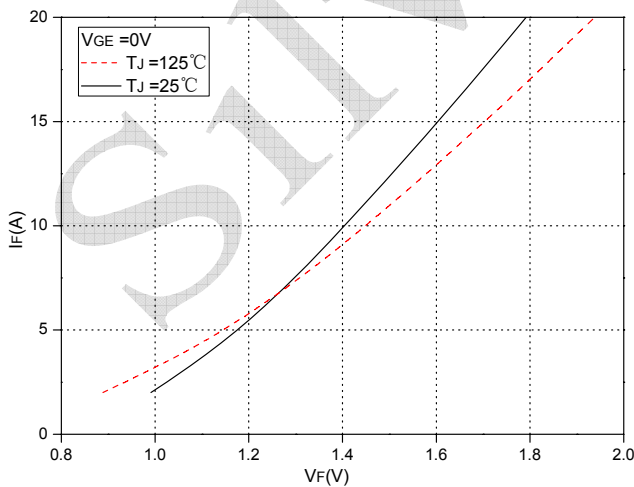

Fig.11 Forward Characteristics of FWD (Brake-Chopper)

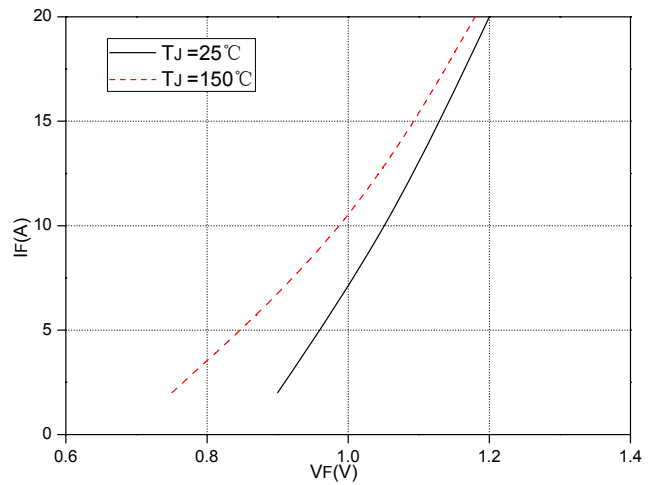

Fig.12 Forward Characteristics of Diode (Rectifier)

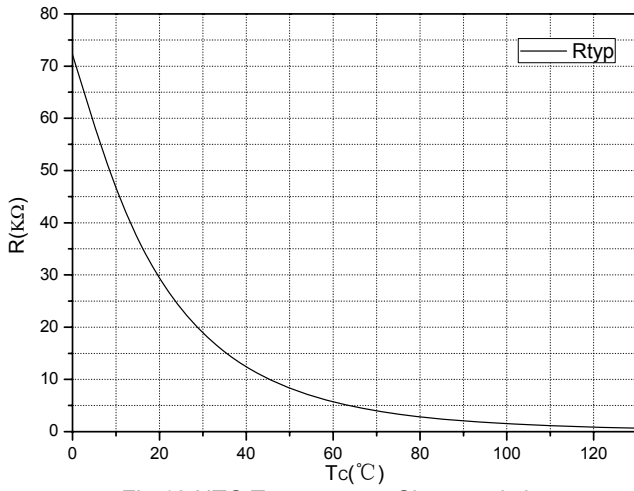
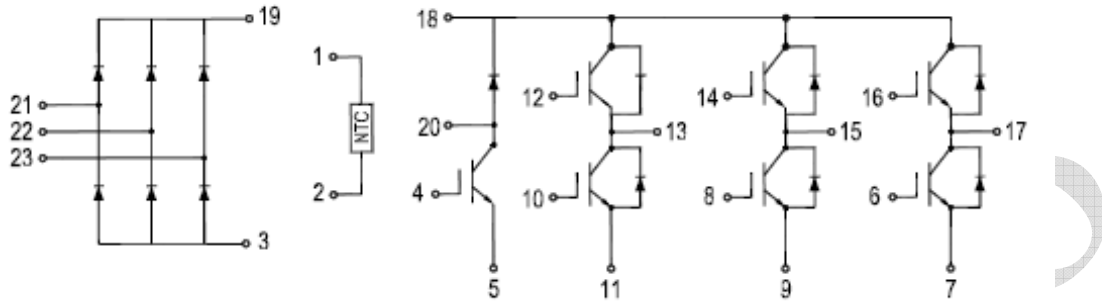

Fig.13 NTC Temperature Characteristics

SilverMicro

Internal Circuit:



SilverMicro

Package Outline (Unit: mm):

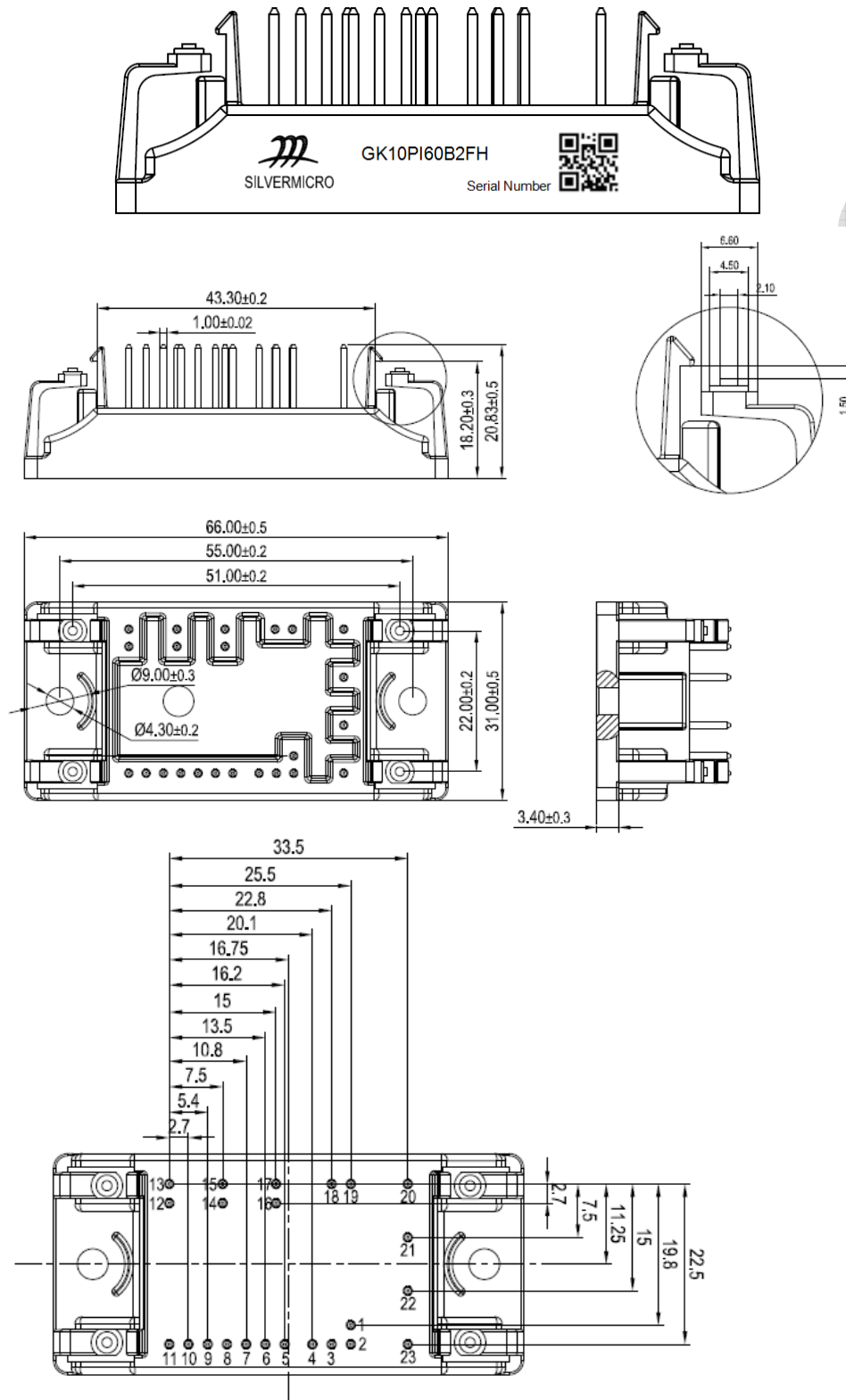

Announcement

Information in this document is believed to be accurate and reliable. However, NJSME does not give any representations or warranties, expressed or implied, as to the accuracy or completeness of such information and shall have no liability for the consequences of use of such information.

Right to make changes

NJSME reserves the right to make changes to information published in this document, including without limitation specifications and product descriptions, at any time and without notice. This document supersedes and replaces all information supplied prior to the publication hereof.

SilverMicro