

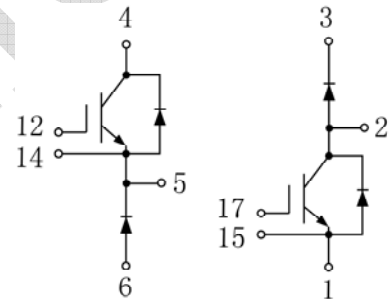
# GT150CH120T2H

## IGBT Module

Preliminary Data

### Features:

- Short Circuit Rated 10 $\mu$ s
- Low Saturation Voltage:  $V_{CE(sat)} = 1.90V @ I_C = 150A, T_C=25^\circ C$
- Low Switching Loss
- 100% RBSOA Tested (2 $\times$ I<sub>C</sub>)
- Low Stray Inductance
- Lead Free, Compliant with RoHS Requirement



### Applications:

- Industrial Motor Drive
- UPS、SMPS
- Servo Drive、Switched Reluctance Drive

### IGBT, Brake-Chopper

Maximum Rated Values ( $T_C=25^\circ C$  Unless otherwise specified)

$V_{CES}$	Collector-Emitter Blocking Voltage		1200	V
$V_{GES}$	Gate-Emitter Voltage		$\pm 20$	V
$I_C$	Continuous Collector Current	$T_C = 80^\circ C,$	150	A
		$T_C = 25^\circ C$	230	A
$I_{CM}$	Peak Collector Current Repetitive	$T_J = 175^\circ C$	300	A
$t_{SC}$	Short Circuit Withstand Time		>10	$\mu s$
$P_D$	Maximum Power Dissipation (IGBT)	$T_C = 25^\circ C$ $T_{Jmax}=175^\circ C$	867	W

## Electrical Characteristics of IGBT ( $T_C=25^\circ\text{C}$ Unless otherwise specified)

### Static characteristics

Symbol	Description	Conditions	Min	Typ	Max	Unit
$V_{GE(th)}$	Gate-Emitter Threshold Voltage	$I_C = 1\text{mA}, V_{CE} = V_{GE}$	5.0	5.5	6.0	V
$V_{CE(sat)}$	Collector-Emitter Saturation Voltage	$I_C = 150\text{A}, V_{GE} = 15\text{V}$	$T_J = 25^\circ\text{C}$	1.90	2.20	V
			$T_J = 125^\circ\text{C}$	2.20		V
$I_{CES}$	Collector-Emitter Leakage Current	$V_{GE} = 0\text{V}, V_{CE} = V_{CES}, T_J = 25^\circ\text{C}$			1	mA
$I_{GES}$	Gate-Emitter Leakage Current	$V_{GE} = \pm 20\text{V}, V_{CE} = 0\text{V}, T_J = 25^\circ\text{C}$			200	nA
$C_{ies}$	Input Capacitance	$V_{CE} = 25\text{V}, V_{GE} = 0\text{V}, f = 1\text{MHz}$		20.9		nF
$C_{oes}$	Output capacitance			0.72		nF
$C_{res}$	Reveres transfer capacitance			0.46		nF

### Switching Characteristics

$t_{d(on)}$	Turn-on Delay Time	$V_{CC} = 600\text{V}, I_C = 150\text{A}, R_G = 15\Omega, V_{GE} = \pm 15\text{V},$ Inductive Load	$T_J = 25^\circ\text{C}$		301		ns
			$T_J = 125^\circ\text{C}$		275		
$t_r$	Rise Time		$T_J = 25^\circ\text{C}$		176		ns
			$T_J = 125^\circ\text{C}$		178		
$t_{d(off)}$	Turn-off Delay Time		$T_J = 25^\circ\text{C}$		485		ns
			$T_J = 125^\circ\text{C}$		501		
$t_f$	Fall Time		$T_J = 25^\circ\text{C}$		181		ns
			$T_J = 125^\circ\text{C}$		252		
$E_{on}$	Turn-on Switching Loss		$T_J = 25^\circ\text{C}$		13.8		mJ
			$T_J = 125^\circ\text{C}$		17.6		
$E_{off}$	Turn-off Switching Loss	$T_J = 25^\circ\text{C}$		8.6		mJ	
		$T_J = 125^\circ\text{C}$		12.1			
$Q_g$	Total Gate Charge	$T_J = 25^\circ\text{C}$		1280		nC	
RBSOA	RBSOA	$I_C=300\text{A}, V_{CC}=1050\text{V}, V_p=1200\text{V}, R_g = 15\Omega, V_{GE}=\pm 15\text{V to } 0\text{V}, T_J = 150^\circ\text{C}$	Trapezoid				
SCSOA	SCSOA	$V_{CC} = 600\text{V}, V_{GE} = 15\text{V}, T_J = 150^\circ\text{C}$	10			$\mu\text{s}$	
$R_{\theta JC}$	IGBT Thermal Resistance: Junction-To-Case			0.173		$^\circ\text{C/W}$	

### Diode, Reverse

#### Maximum Rated Values ( $T_C=25^\circ\text{C}$ Unless otherwise specified)

$V_{RRM}$	Repetitive peak reverse voltage	1200	V
$I_F$	Diode Continuous Forward Current	150	A
$I_{FM}$	Peak FWD Current Repetitive	300	A

#### Electrical Characteristics of FWD ( $T_C=25^\circ\text{C}$ Unless otherwise specified)

Symbol	Description	Conditions		Min	Typ	Max	Unit
$V_{FM}$	Forward Voltage	$I_F = 150\text{A}$ , $V_{GE} = 0\text{V}$	$T_J = 25^\circ\text{C}$		2.20	2.40	V
			$T_J = 125^\circ\text{C}$		2.40		
$I_{rr}$	Peak Reverse Recovery Current		$T_J = 25^\circ\text{C}$		45		A
			$T_J = 125^\circ\text{C}$		70		
$Q_{rr}$	Reverse Recovery Charge	$I_F = 150\text{A}$ , $di/dt = 660\text{A}/\mu\text{s}$ , $V_{rr} = 600\text{V}$ , $V_{GE} = -15\text{V}$	$T_J = 25^\circ\text{C}$		5.5		$\mu\text{C}$
			$T_J = 125^\circ\text{C}$		12.9		
$E_{rec}$	Reverse Recovery Energy		$T_J = 25^\circ\text{C}$		2.0		mJ
			$T_J = 125^\circ\text{C}$		4.7		
$R_{\theta JC}$	Diode Thermal Resistance: Junction-To-Case				0.286		$^\circ\text{C}/\text{W}$

### Diode, Brake-Chopper

#### Maximum Rated Values ( $T_C=25^\circ\text{C}$ Unless otherwise specified)

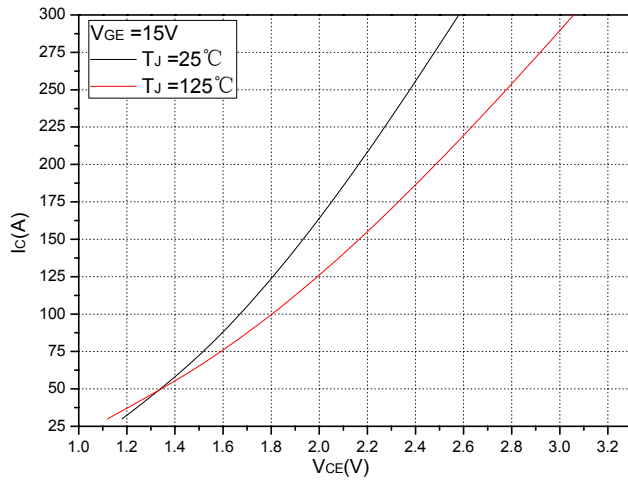
$V_{RRM}$	Repetitive peak reverse voltage	1200	V
$I_F$	Diode Continuous Forward Current	150	A
$I_{FM}$	Peak FWD Current Repetitive	300	A

### Electrical Characteristics of FWD ( $T_C=25^{\circ}\text{C}$ Unless otherwise specified)

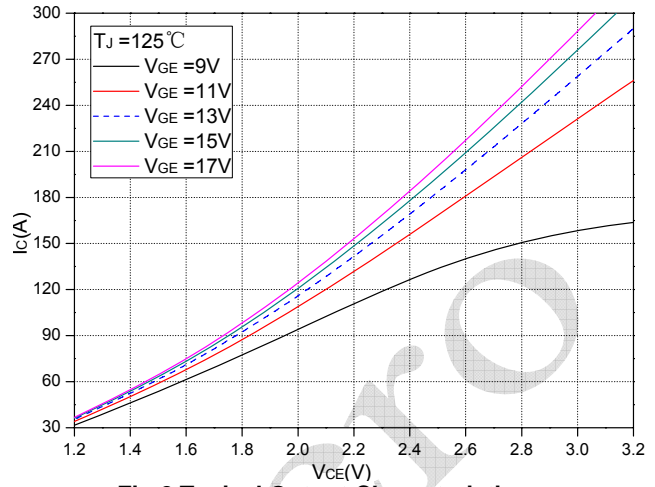
Symbol	Description	Conditions	Min	Typ	Max	Unit	
$V_{FM}$	Forward Voltage	$I_F = 150\text{A}$ , $V_{GE} = 0\text{V}$	$T_J = 25^{\circ}\text{C}$		1.80	2.00	V
			$T_J = 125^{\circ}\text{C}$		2.00		
$R_{\theta JC}$	Diode Thermal Resistance: Junction-To-Case			0.201		$^{\circ}\text{C}/\text{W}$	

### Module

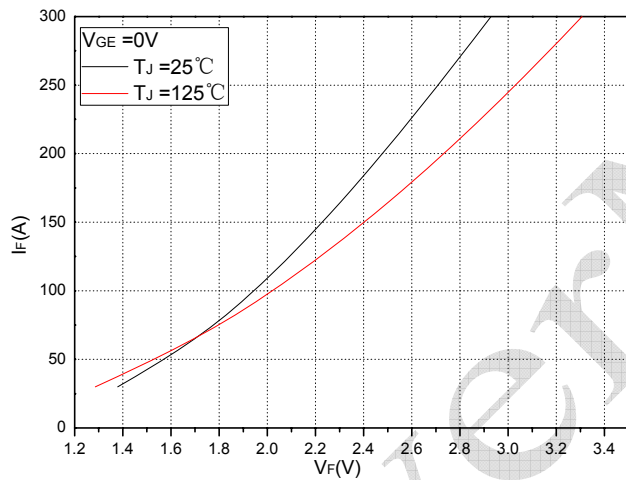
Symbol	Description	Min	Typ	Max	Unit	
$V_{iso}$	Isolation Voltage(All Terminals Shorted)	$f = 50\text{Hz}$ , 1minute	2500		V	
$T_J$	Maximum Junction Temperature			175	$^{\circ}\text{C}$	
$T_{JOP}$	Maximum Operating Junction Temperature Range		-40 +150		$^{\circ}\text{C}$	
$T_{stg}$	Storage Temperature		-40 +125		$^{\circ}\text{C}$	
$R_{\theta CS}$	Case-To-Sink (Conductive Grease Applied)			0.03	$^{\circ}\text{C}/\text{W}$	
M	Power Terminals Screw:M5		3.0		5.0	N·m
M	Mounting Screw:M6		4.0		6.0	N·m
G	Weight			280		g



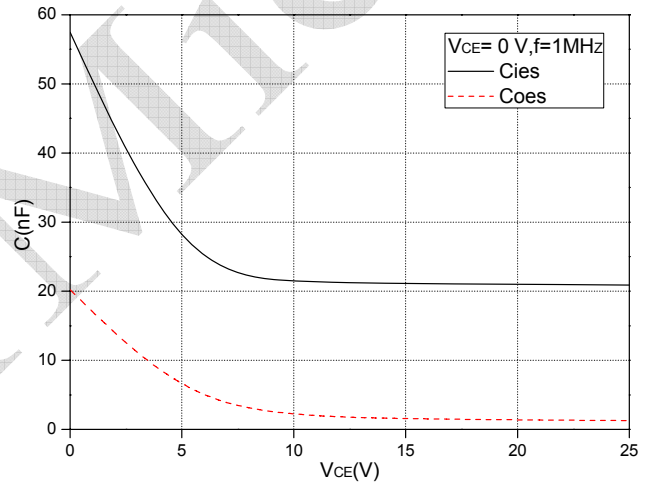
**Fig.1 Typical Saturation Voltage Characteristics**



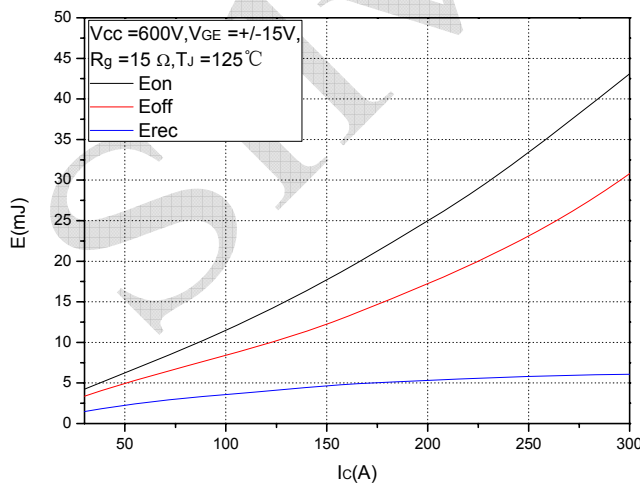
**Fig.2 Typical Output Characteristics**



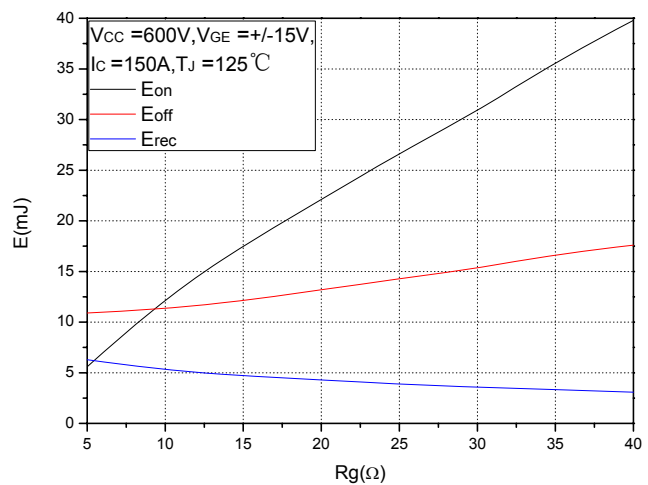
**Fig.3 Forward Characteristics of FWD (Reverse)**



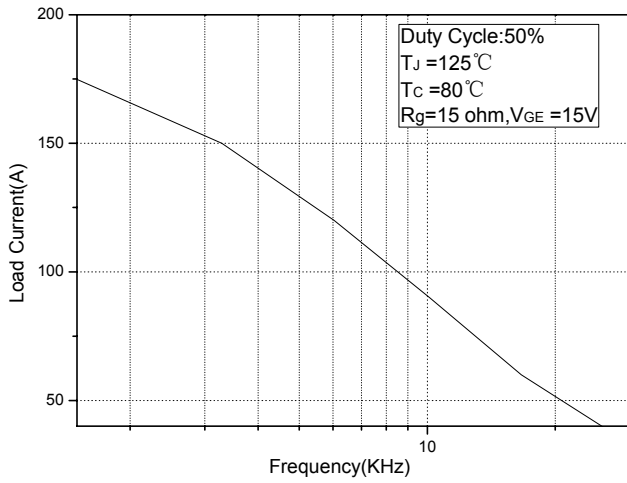
**Fig.4 Capacitance Characteristics**



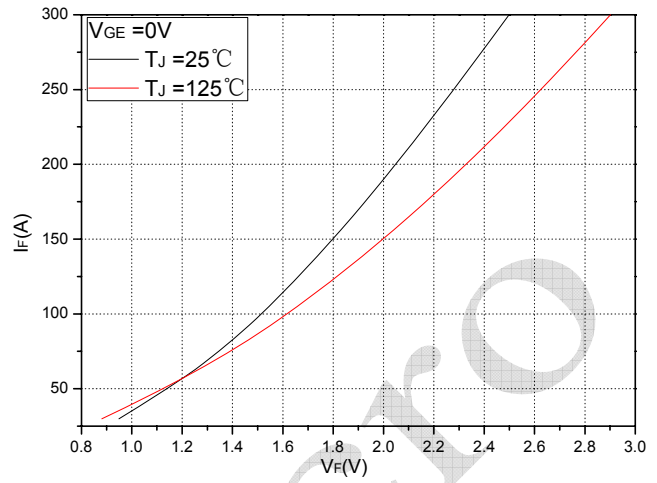
**Fig.5 Typical Switching Loss vs. Collector Current**



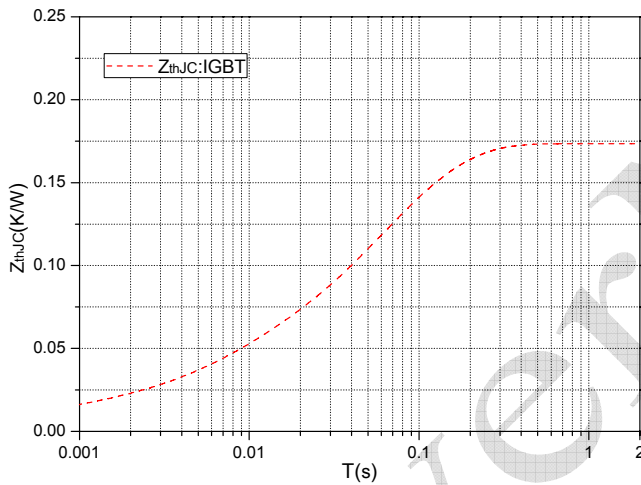
**Fig.6 Typical Switching Loss vs. Gate Resistance**



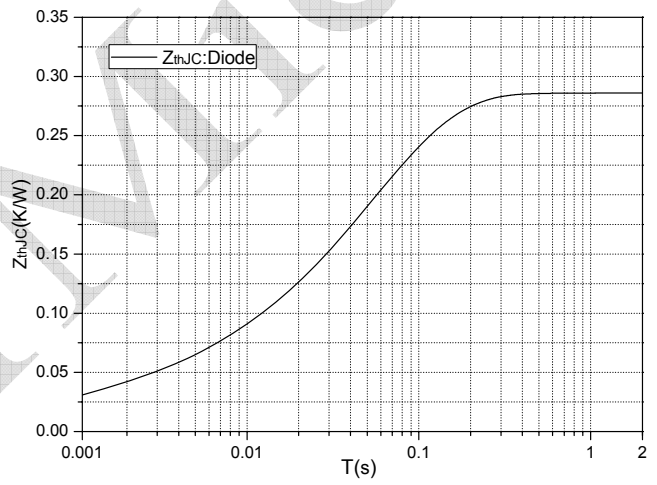
**Fig.7 Typical Load Current vs. Frequency**



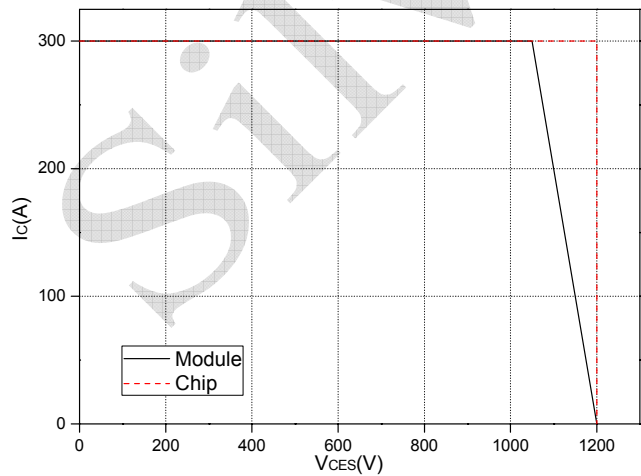
**Fig.8 Forward Characteristics of Diode (Brake-Chopper)**



**Fig.9 Transient thermal impedance (IGBT)**

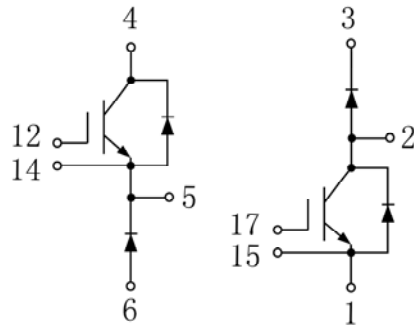


**Fig.10 Transient thermal impedance (Diode)**

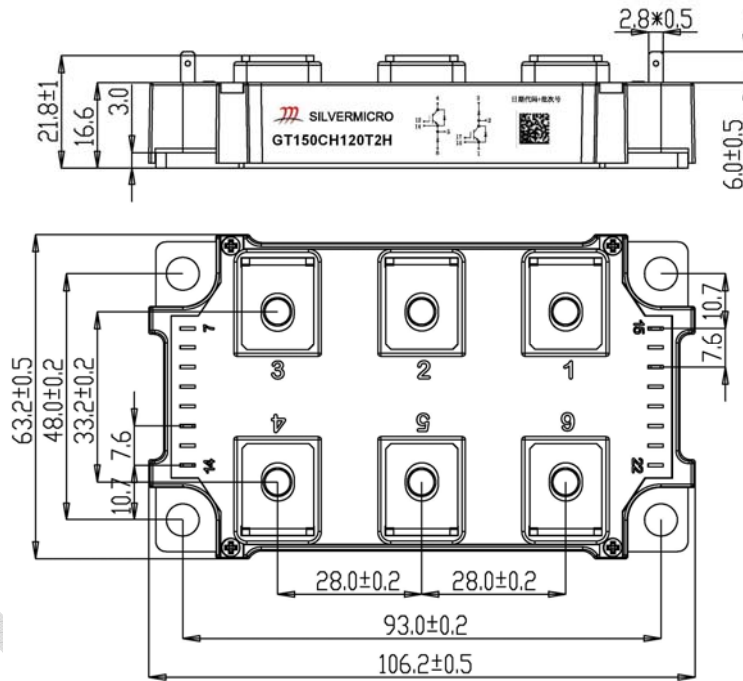


**Fig.11 Reverse Bias Safe Operation Area (RBSOA)**

**Internal Circuit:**



**Package Outline (Unit: mm):**



**Announcement**

Information in this document is believed to be accurate and reliable. However, NJSME does not give any representations or warranties, expressed or implied, as to the accuracy or completeness of such information and shall have no liability for the consequences of use of such information.

**Right to make changes**

NJSME reserves the right to make changes to information published in this document, including without limitation specifications and product descriptions, at any time and without notice. This document supersedes and replaces all information supplied prior to the publication hereof.

SilverMicro