

GT150HF120T2VH-M

IGBT Module

Preliminary Data

Features:

- Field Stop Trench Gate IGBT
- Short Circuit Rated $> 10\mu\text{s}$
- Low Saturation Voltage
- Low Switching Loss
- 100% RBSOA Tested ($2 \times I_c$)
- Low Stray Inductance
- Lead Free, Compliant with RoHS Requirement

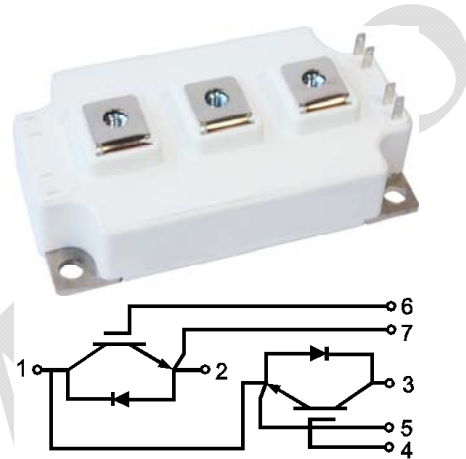

Applications:

- Welding
- HEV Inverter
- Industrial Motor Drives
- UPS

Maximum Rated Values of IGBT ($T_C=25^\circ\text{C}$ unless otherwise specified)

V_{CES}	Collector-Emitter Blocking Voltage		1200	V
V_{GES}	Gate-Emitter Voltage		± 20	V
I_c	Continuous Collector Current	$T_C = 100^\circ\text{C}$	150	A
		$T_C = 25^\circ\text{C}$	300	A
I_{CM}	Repetitive Peak Collector Current	$T_J = 175^\circ\text{C}$	300	A
t_{SC}	Short Circuit Withstand Time		> 10	μs
P_D	Maximum Power Dissipation per IGBT	$T_C = 25^\circ\text{C}$ $T_{Jmax} = 175^\circ\text{C}$	1085	W

Electrical Characteristics of IGBT ($T_C=25^\circ\text{C}$ unless otherwise specified)

Static Characteristics

Symbol	Description	Conditions	Min	Typ	Max	Unit
$V_{GE(th)}$	Gate-Emitter Threshold Voltage	$I_C=4\text{mA}, V_{CE}=V_{GE}$	5.0	5.9	6.6	V
$V_{CE(sat)}$	Collector-Emitter Saturation Voltage	$I_C=150\text{A}, V_{GE}=15\text{V}$	$T_J=25^\circ\text{C}$	1.70	2.00	V
			$T_J=125^\circ\text{C}$	1.90		V
			$T_J=150^\circ\text{C}$	2.00		
I_{CES}	Collector-Emitter Leakage Current	$V_{GE}=0\text{V}, V_{CE}=V_{CES}, T_J = 25^\circ\text{C}$			1	mA
I_{GES}	Gate-Emitter Leakage Current	$V_{GE}=\pm 20\text{V}, V_{CE}=0\text{V}, T_J=25^\circ\text{C}$			400	nA
C_{ies}	Input Capacitance	$V_{CE}=25\text{V}, V_{GE}=0\text{V}, f=1\text{MHz}$		10.13		nF
C_{oes}	Out Capacitance			1.01		nF
C_{res}	Reverse Transfer Capacitance			0.77		nF

Switching Characteristics

$t_{d(on)}$	Turn-on Delay Time	$V_{CC}=600\text{V}, I_C=150\text{A}, R_{Gon}=4.7\Omega, V_{GE}=\pm 15\text{V},$ Inductive Load	$T_J=25^\circ\text{C}$	258		ns
			$T_J=125^\circ\text{C}$	258		
			$T_J=150^\circ\text{C}$	260		
t_r	Rise Time		$T_J=25^\circ\text{C}$	85		ns
			$T_J=125^\circ\text{C}$	89		
			$T_J=150^\circ\text{C}$	89		
$t_{d(off)}$	Turn-off Delay Time		$T_J=25^\circ\text{C}$	265		ns
			$T_J=125^\circ\text{C}$	277		
			$T_J=150^\circ\text{C}$	284		
t_f	Fall Time	$T_J=25^\circ\text{C}$	205		ns	
		$T_J=125^\circ\text{C}$	376			
		$T_J=150^\circ\text{C}$	428			
E_{on}	Turn-on Switching Loss	$V_{CC}=600\text{V}, I_C=150\text{A}, R_{Gon}=4.7\Omega, V_{GE}=\pm 15\text{V},$ $di/dt=1550\text{A}/\mu\text{s} (T_J=150^\circ\text{C})$ Inductive Load	$T_J=25^\circ\text{C}$	12.5		mJ
			$T_J=125^\circ\text{C}$	15.7		
			$T_J=150^\circ\text{C}$	17.5		

E _{off}	Turn-off Switching Loss	V _{CC} =600V, I _C =150A, R _{Goff} =4.7Ω, V _{GE} = ±15V, du/dt=4106V/μs (T _J =150°C) Inductive Load	T _J =25°C	10.3	mJ
			T _J =125°C	15.8	
			T _J =150°C	17.4	
Q _g	Total Gate Charge	V _{GE} =+15V...-15V	T _J =25°C	0.71	μC
RBSOA	I _C =300A, V _{CC} =1050V, V _p =1200V, R _{Goff} =4.7Ω, V _{GE} =+15V to 0V, T _J =150°C			Trapezoid	
SC Data	V _{CC} =600V, R _{Gon} =4.7 Ω, R _{Goff} =4.7 Ω, tp=10us, V _{GE} =+/-15V, T _J =125°C			680	A
R _{θJC}	IGBT Thermal Resistance: Junction-To-Case(per leg)			0.138	°C/W

Maximum Rated Values of Diode (T_C=25°C unless otherwise specified)

V _{RRM}	Repetitive Peak Reverse Voltage	1200	V
I _F	Diode Continuous Forward Current	150	A
I _{FM}	Diode Maximum Forward Current	300	A

Electrical Characteristics of Diode (T_C=25°C unless otherwise specified)

Symbol	Description	Conditions	Min	Typ	Max	Unit
V _{FM}	Forward Voltage	I _F =150A	T _J =25°C	1.50		V
			T _J =125°C	1.50		
			T _J =150°C	1.50		
t _{rr}	Reverse Recovery Time		T _J =25°C	371		ns
			T _J =125°C	562		
			T _J =150°C	625		
I _{rr}	Peak Reverse Recovery Current	I _F =150A, -diF/dt=1670A/μs(T _J =150°C), V _R =600V, V _{GE} =-15V	T _J =25°C	127		A
			T _J =125°C	142		
			T _J =150°C	145		
Q _{rr}	Reverse Recovery Charge		T _J =25°C	22.6		μC
			T _J =125°C	34.6		
			T _J =150°C	39.4		

E _{rec}	Reverse Recovery Energy	I _F =150A, -diF/dt=1670A/μs(T _J =150°C), V _R =600V, V _{GE} =-15V	T _J =25°C	9.7	mJ
			T _J =125°C	15.2	
			T _J =150°C	17.6	
R _{θJC}	Diode Thermal Resistance: Junction-To-Case (per leg)			0.213	°C/W

Module

Symbol	Description		Min	Typ	Max	Unit
V _{iso}	Isolation Voltage (All Terminals Shorted)	f = 50Hz, 1minute	2500			V
T _J	Maximum Junction Temperature				175	°C
T _{JOP}	Maximum Operating Junction Temperature Range		-40		+150	°C
T _{stg}	Storage Temperature		-40		+125	°C
CTI	Comparative Tracking Index		200			V
R _{θCS}	Case-To-Sink Thermally (Conductive Grease Applied)			0.03		°C/W
T	Power Terminals Screw:M6		3.0		5.0	N·m
T	Mounting Screw:M6		4.0		6.0	N·m
G	Weight			300		g

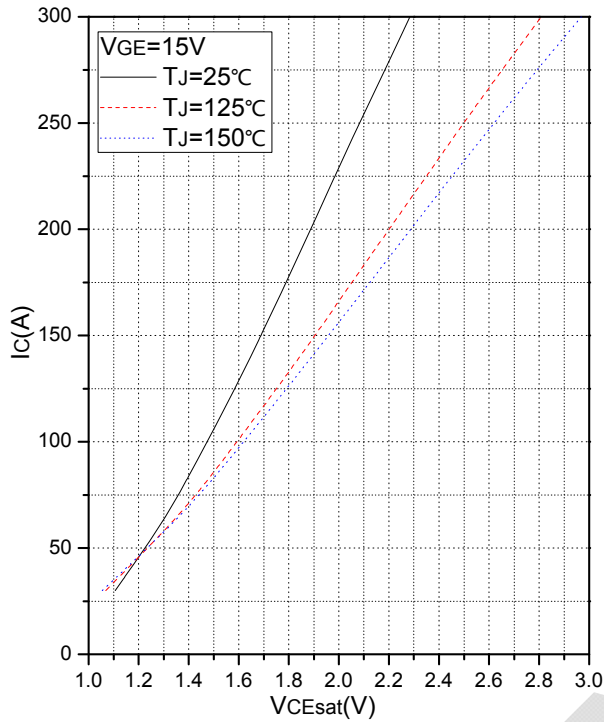

Fig.1 Typical Saturation Voltage Characteristics

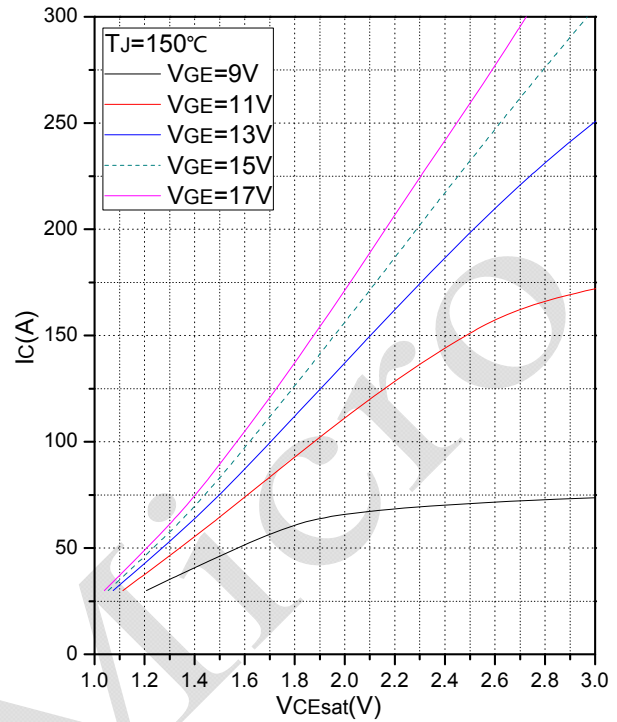

Fig.2 Typical Output Characteristics

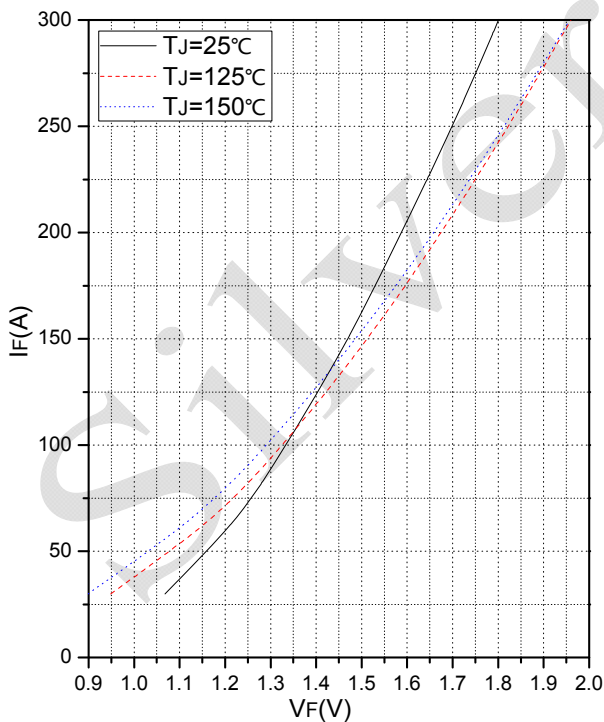

Fig.3 Forward Characteristics of Diode

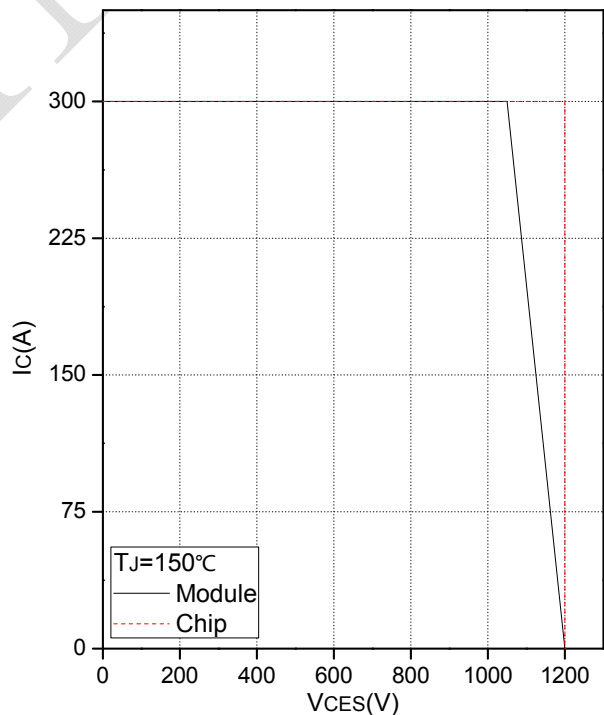

Fig.4 Reverse Bias Safe Operation Area (RBSOA)

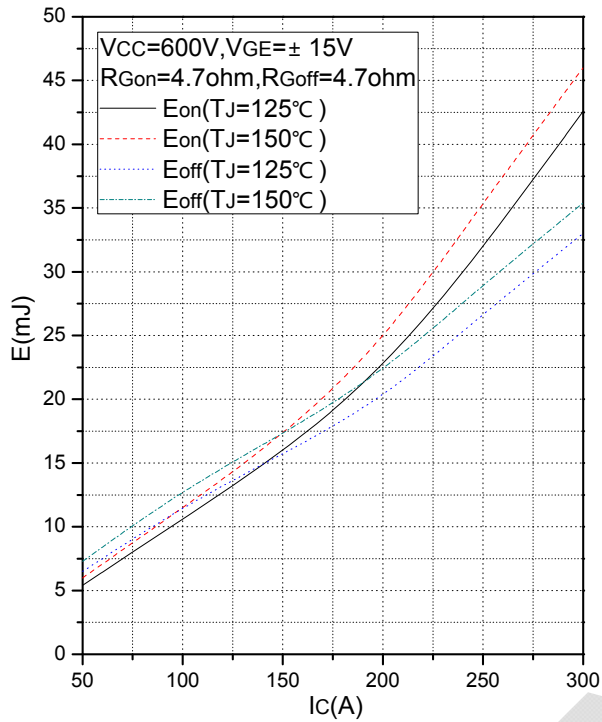

Fig.5 Typical Switching Loss vs. Collector Current

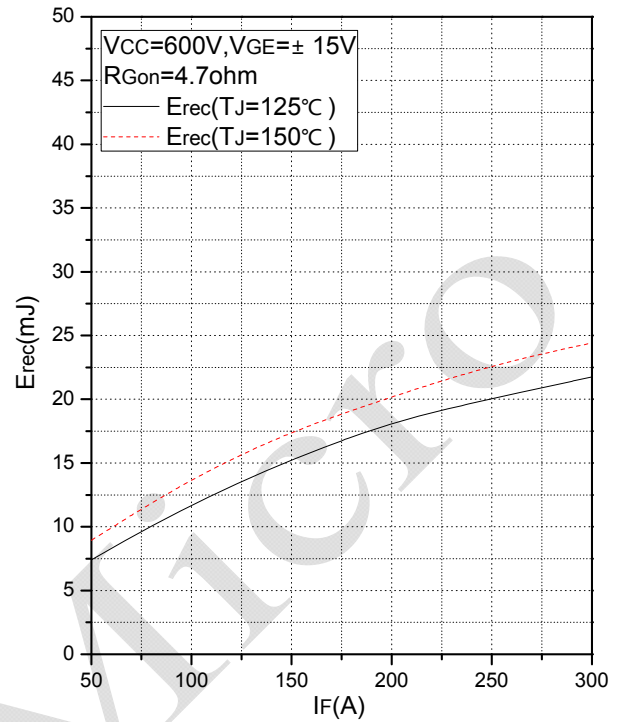

Fig.6 Typical Switching Loss vs. Forward Current

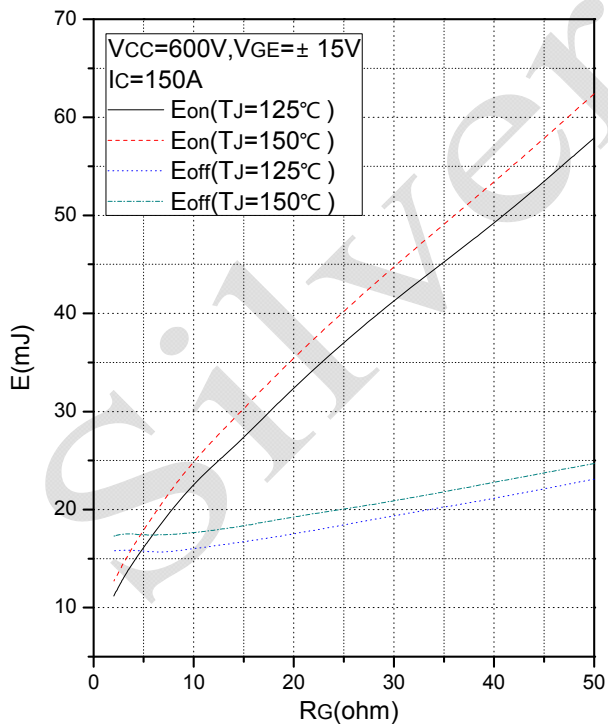

Fig.7 Typical Switching Loss vs. Gate Resistance

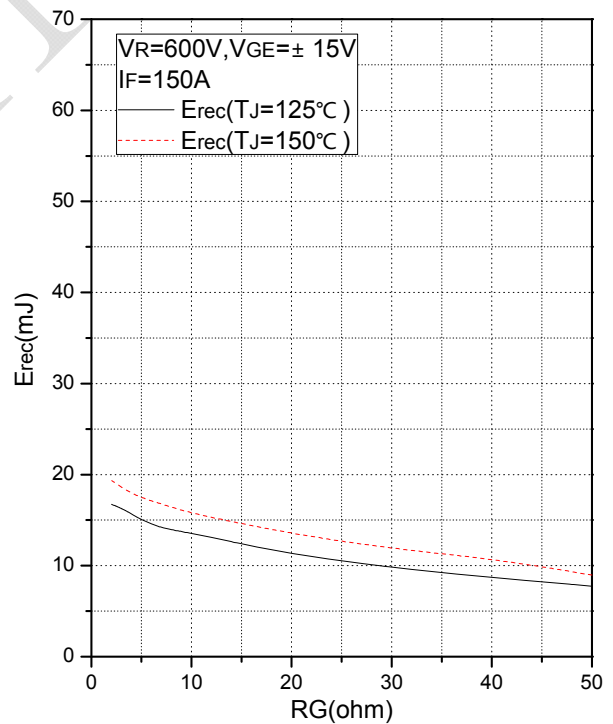

Fig.8 Typical Switching Loss vs. Gate Resistance

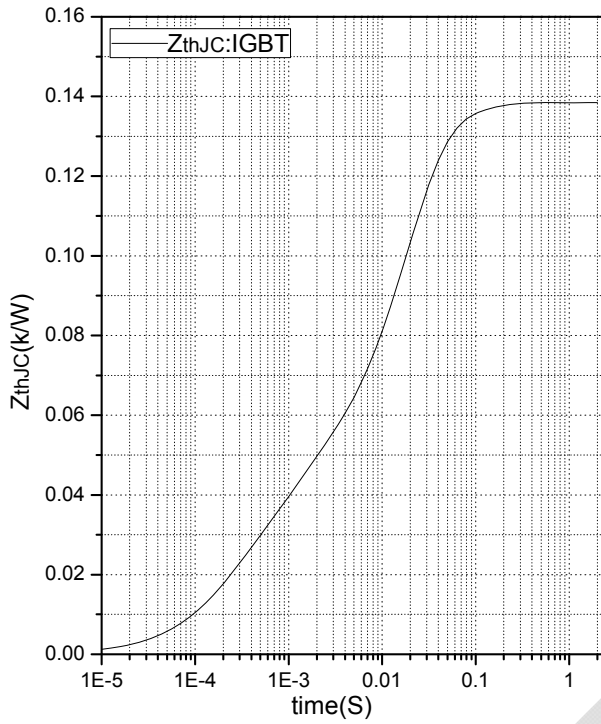

Fig.9 Transient Thermal Impedance (IGBT)

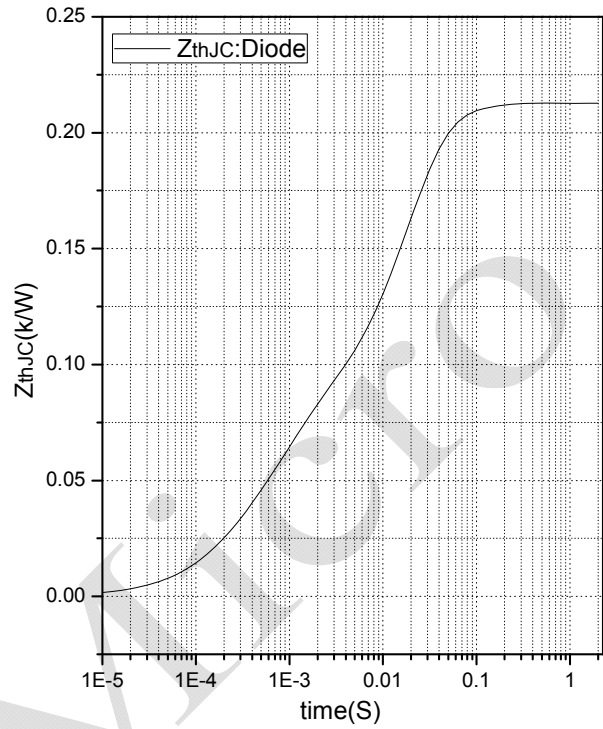

Fig.10 Transient Thermal Impedance (Diode)

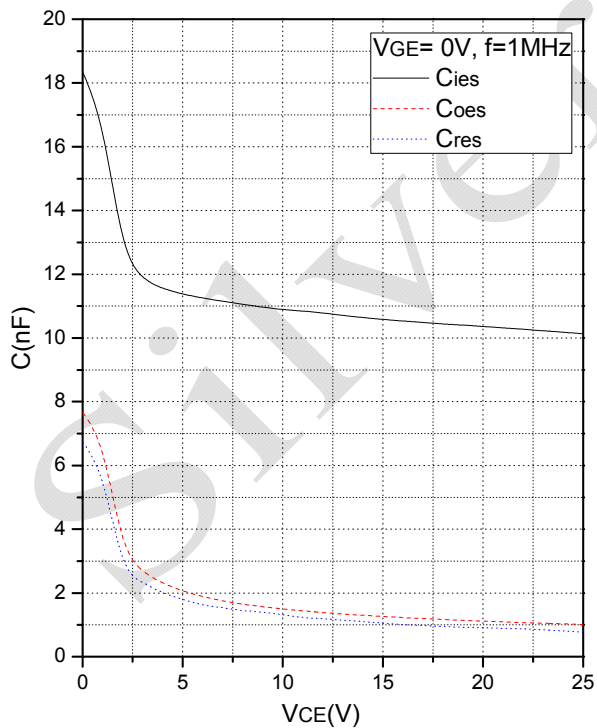
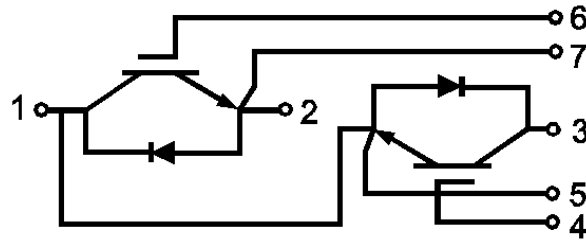
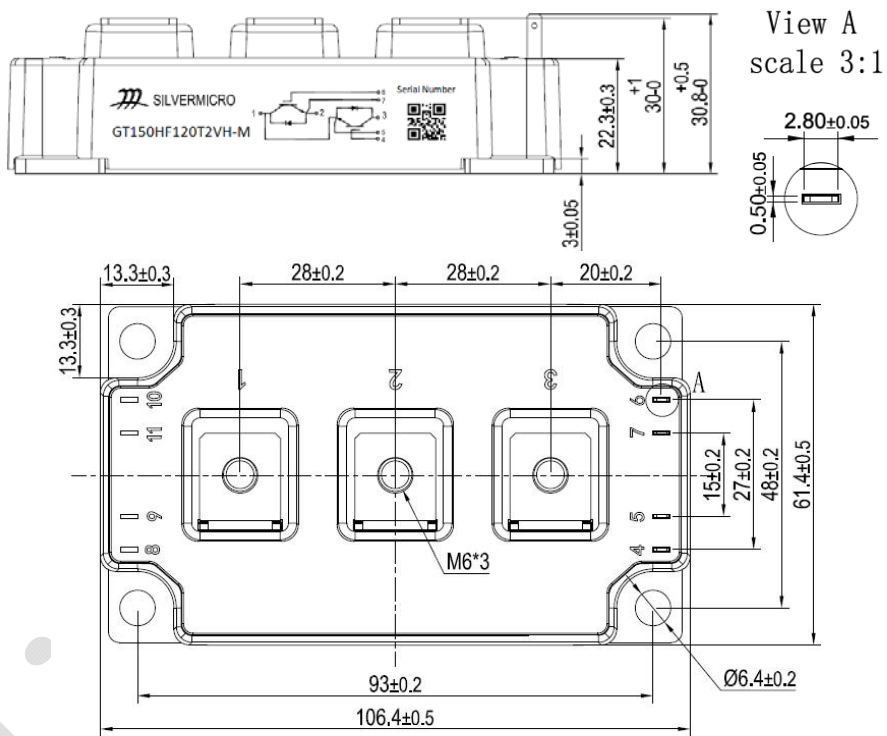

Fig.11 Capacitance Characteristics

Internal Circuit



Package Outline (Unit: mm):





Date	Revision	Notes
06/13/2018	01	Initial release

Announcement

Information in this document is believed to be accurate and reliable. However, NJSME does not give any representations or warranties, expressed or implied, as to the accuracy or completeness of such information and shall have no liability for the consequences of use of such information.

Right to Make Changes

NJSME reserves the right to make changes to information published in this document, including without limitation specifications and product descriptions, at any time and without notice. This document supersedes and replaces all information supplied prior to the publication hereof.