

# GT300HF120T2VH-M

## IGBT Module

Preliminary Data

### Features:

- Field Stop Trench Gate IGBT
- Short Circuit Rated  $> 10\mu\text{s}$
- Low Saturation Voltage
- Low Switching Loss
- 100% RBSOA Tested ( $2 \times I_c$ )
- Low Stray Inductance
- Lead Free, Compliant with RoHS Requirement

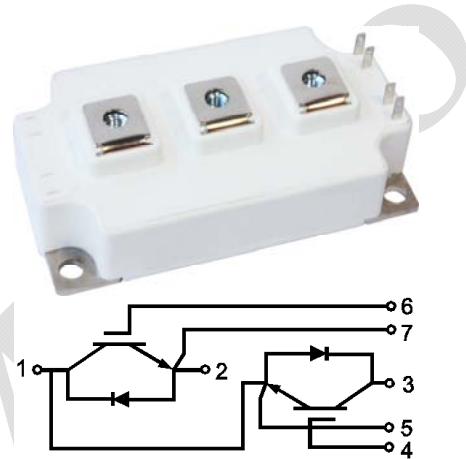

### Applications:

- Welding
- HEV Inverter
- Industrial Motor Drives
- UPS

### Maximum Rated Values of IGBT ( $T_C=25^\circ\text{C}$ unless otherwise specified)

$V_{CES}$	Collector-Emitter Blocking Voltage		1200	V
$V_{GES}$	Gate-Emitter Voltage		$\pm 20$	V
$I_C$	Continuous Collector Current	$T_C=100^\circ\text{C}$	300	A
		$T_C=25^\circ\text{C}$	580	A
$I_{CM}$	Repetitive Peak Collector Current	$T_J=175^\circ\text{C}$	600	A
$t_{SC}$	Short Circuit Withstand Time		$> 10$	$\mu\text{s}$
$P_D$	Maximum Power Dissipation per IGBT	$T_C=25^\circ\text{C}$ $T_{Jmax}=175^\circ\text{C}$	1975	W

## Electrical Characteristics of IGBT ( $T_C=25^\circ\text{C}$ unless otherwise specified)

### Static Characteristics

Symbol	Description	Conditions	Min	Typ	Max	Unit
$V_{GE(th)}$	Gate-Emitter Threshold Voltage	$I_C = 4\text{mA}, V_{CE} = V_{GE}$	5.0	5.6	6.6	V
$V_{CE(sat)}$	Collector-Emitter Saturation Voltage	$I_C = 300\text{A}, V_{GE} = 15\text{V}$	$T_J=25^\circ\text{C}$	1.70	1.90	V
			$T_J=125^\circ\text{C}$	1.90		V
			$T_J=150^\circ\text{C}$	2.00		V
$I_{CES}$	Collector-Emitter Leakage Current	$V_{GE} = 0\text{V}, V_{CE} = V_{CES}, T_J = 25^\circ\text{C}$			1	mA
$I_{GES}$	Gate-Emitter Leakage Current	$V_{GE} = \pm 20\text{V}, V_{CE} = 0\text{V}, T_J = 25^\circ\text{C}$			400	nA
$C_{ies}$	Input Capacitance	$V_{CE} = 25\text{V}, V_{GE} = 0\text{V}, f = 1\text{MHz}$		25.2		nF
$C_{res}$	Reverse Transfer Capacitance			0.86		nF

### Switching Characteristics

$t_{d(on)}$	Turn-on Delay Time	$V_{CC} = 600\text{V}, I_C = 300\text{A}, R_{Gon} = 2\Omega, V_{GE} = \pm 15\text{V},$ Inductive Load	$T_J=25^\circ\text{C}$	0.39		$\mu\text{s}$
			$T_J=125^\circ\text{C}$	0.40		
			$T_J=150^\circ\text{C}$	0.40		
$t_r$	Rise Time		$T_J=25^\circ\text{C}$	0.13		$\mu\text{s}$
			$T_J=125^\circ\text{C}$	0.13		
			$T_J=150^\circ\text{C}$	0.13		
$t_{d(off)}$	Turn-off Delay Time		$T_J=25^\circ\text{C}$	0.39		$\mu\text{s}$
			$T_J=125^\circ\text{C}$	0.42		
			$T_J=150^\circ\text{C}$	0.42		
$t_f$	Fall Time	$T_J=25^\circ\text{C}$	0.13		$\mu\text{s}$	
		$T_J=125^\circ\text{C}$	0.19			
		$T_J=150^\circ\text{C}$	0.21			
$E_{on}$	Turn-on Switching Loss	$V_{CC} = 600\text{V}, I_C = 300\text{A}, R_{Gon} = 2\Omega, V_{GE} = \pm 15\text{V},$ $di/dt=1880\text{A}/\mu\text{s} (T_J=150^\circ\text{C})$ Inductive Load	$T_J=25^\circ\text{C}$	20.6		mJ
			$T_J=125^\circ\text{C}$	27.3		
			$T_J=150^\circ\text{C}$	29.7		

E <sub>off</sub>	Turn-off Switching Loss	V <sub>CC</sub> = 600V, I <sub>C</sub> = 300A, R <sub>Goff</sub> = 2Ω, V <sub>GE</sub> = ±15V, du/dt=3300V/μs ( T <sub>J</sub> =150°C) Inductive Load	T <sub>J</sub> =25°C	26.7	mJ
			T <sub>J</sub> =125°C	35.6	
			T <sub>J</sub> =150°C	38.3	
Q <sub>g</sub>	Total Gate Charge	V <sub>GE</sub> =+15V...-15V	T <sub>J</sub> =25°C	1.56	μC
R <sub>g internal</sub>	Internal Gate Resistance		T <sub>J</sub> =25°C	2.5	Ω
RBSOA	I <sub>C</sub> =600A, V <sub>CC</sub> =1050V, V <sub>p</sub> =1200V, R <sub>Goff</sub> = 2Ω, V <sub>GE</sub> =+15V to 0V, T <sub>J</sub> =150°C			Trapezoid	
I <sub>SC</sub>	SC Data	V <sub>CC</sub> =600V, V <sub>GE</sub> =±15V, R <sub>Gon</sub> =2ohm, R <sub>Goff</sub> =2ohm, tp=10us, T <sub>J</sub> =125°C, Inductive Load		1594	A
R <sub>θJC</sub>	IGBT Thermal Resistance: Junction-To-Case(per leg)			0.076	°C/W

### Maximum Rated Values of Diode (T<sub>C</sub>=25°C unless otherwise specified)

V <sub>RRM</sub>	Repetitive Peak Reverse Voltage	1200	V
I <sub>F</sub>	Diode Continuous Forward Current	300	A
I <sub>FM</sub>	Diode Maximum Forward Current	600	A

### Electrical Characteristics of Diode (T<sub>C</sub>=25°C unless otherwise specified)

Symbol	Description	Conditions	Min	Typ	Max	Unit
V <sub>FM</sub>	Forward Voltage	I <sub>F</sub> =300A	T <sub>J</sub> =25°C	1.80		V
			T <sub>J</sub> =125°C	1.80		
			T <sub>J</sub> =150°C	1.80		
t <sub>rr</sub>	Reverse Recovery Time		T <sub>J</sub> =25°C	0.41		μs
			T <sub>J</sub> =125°C	0.60		
			T <sub>J</sub> =150°C	0.64		
I <sub>rr</sub>	Peak Reverse Recovery Current	I <sub>F</sub> = 300A, -di <sub>F</sub> /dt =2010A/μs(T <sub>J</sub> =150°C), V <sub>R</sub> = 600V, V <sub>GE</sub> = -15V	T <sub>J</sub> =25°C	150		A
			T <sub>J</sub> =125°C	181		
			T <sub>J</sub> =150°C	191		
Q <sub>rr</sub>	Reverse Recovery Charge		T <sub>J</sub> =25°C	29.7		μC
			T <sub>J</sub> =125°C	50.7		
			T <sub>J</sub> =150°C	57.8		

E <sub>rec</sub>	Reverse Recovery Energy	I <sub>F</sub> = 300A, -diF/dt = 2010/μs(T <sub>J</sub> = 150°C), V <sub>R</sub> = 600V, V <sub>GE</sub> = -15V	T <sub>J</sub> = 25°C	12.9	mJ
			T <sub>J</sub> = 125°C	22.0	
			T <sub>J</sub> = 150°C	25.4	
R <sub>θJC</sub>	Diode Thermal Resistance: Junction-To-Case (per leg)			0.134	°C/W

## Module

Symbol	Description		Min	Typ	Max	Unit
V <sub>iso</sub>	Isolation Voltage (All Terminals Shorted)	f = 50Hz, 1minute	2500			V
T <sub>J</sub>	Maximum Junction Temperature				175	°C
T <sub>JOP</sub>	Maximum Operating Junction Temperature Range		-40		+150	°C
T <sub>stg</sub>	Storage Temperature		-40		+125	°C
CTI	Comparative Tracking Index		200			V
R <sub>θCS</sub>	Case-To-Sink Thermally (Conductive Grease Applied)			0.03		°C/W
T	Power Terminals Screw:M6		3.0		5.0	N·m
T	Mounting Screw:M6		4.0		6.0	N·m
G	Weight			300		g

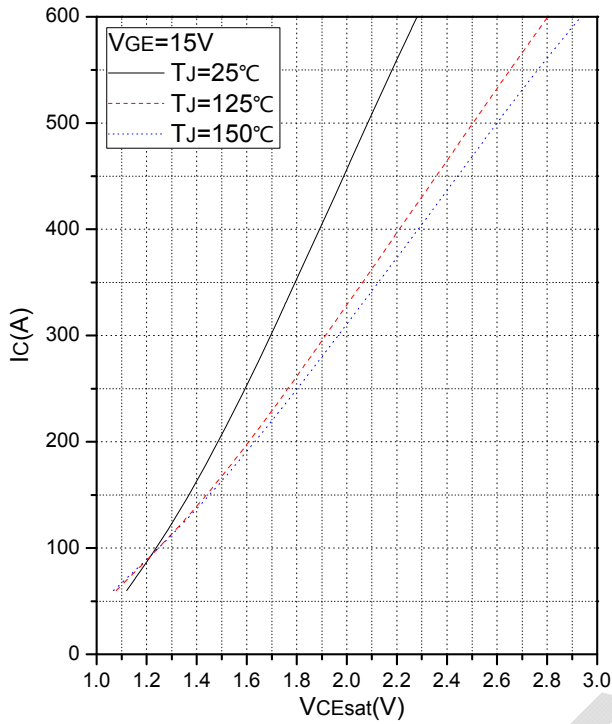

Fig.1 Typical Saturation Voltage Characteristics

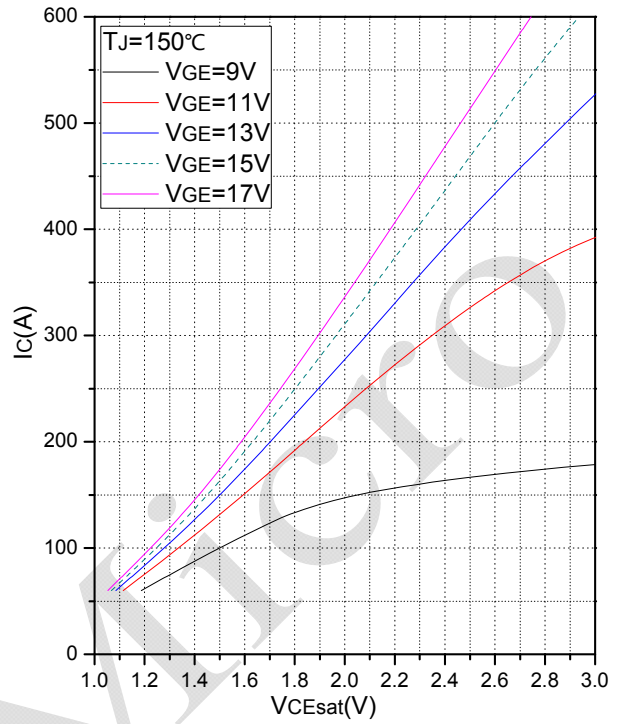

Fig.2 Typical Output Characteristics

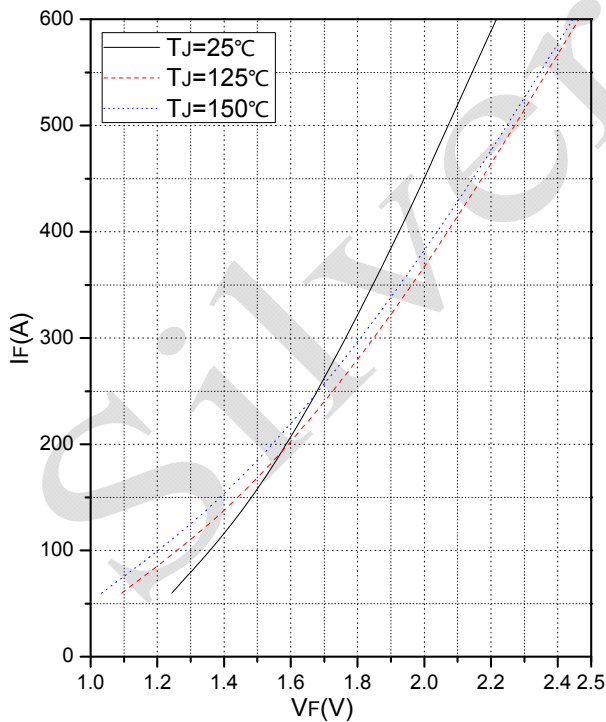

Fig.3 Forward Characteristics of Diode

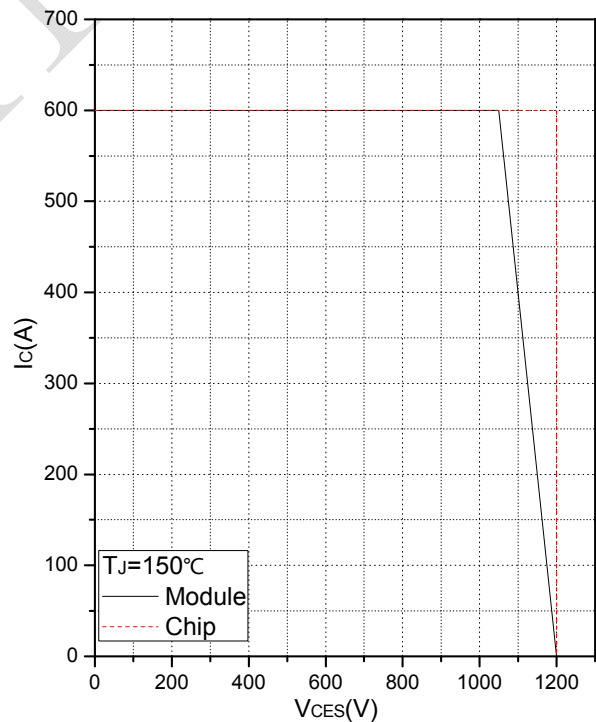

Fig.4 Reverse Bias Safe Operation Area (RBSOA)

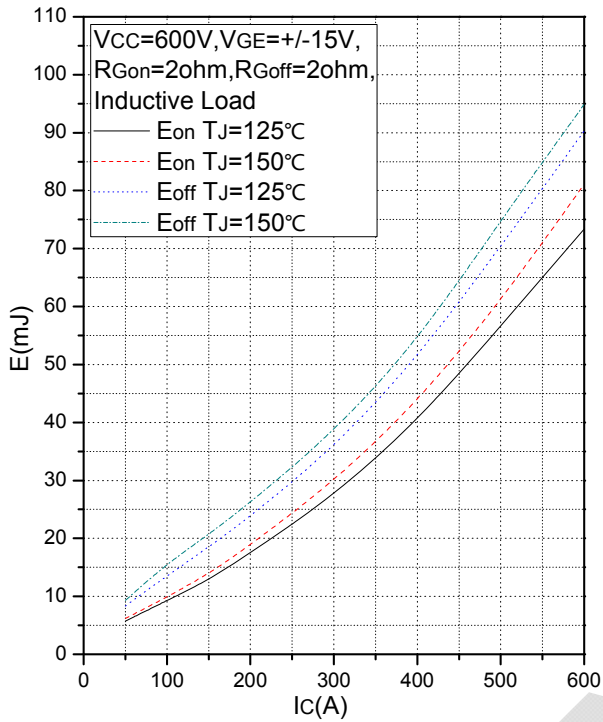

Fig.5 Typical Switching Loss vs. Collector Current

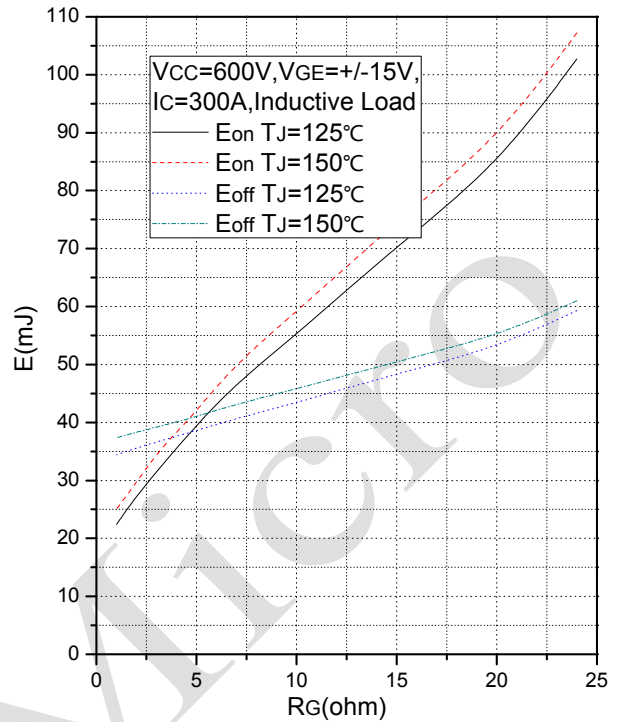

Fig.6 Typical Switching Loss vs. Gate Resistance

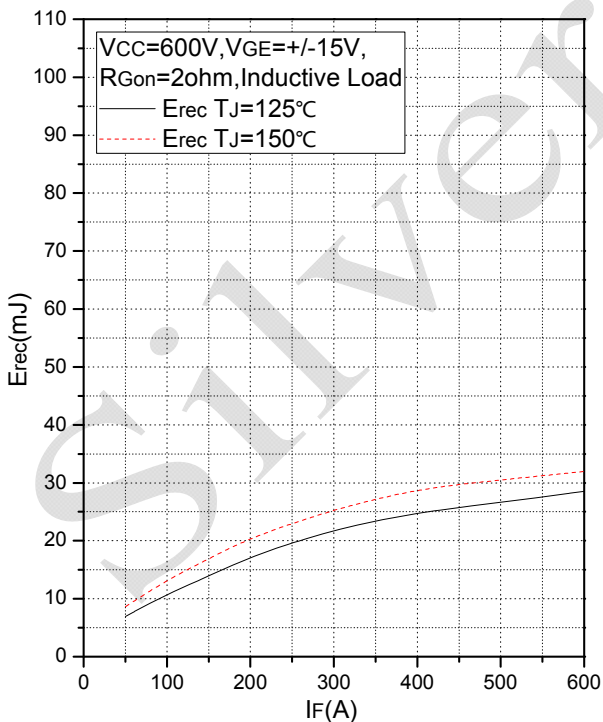

Fig.7 Typical Switching Loss vs. Forward Current

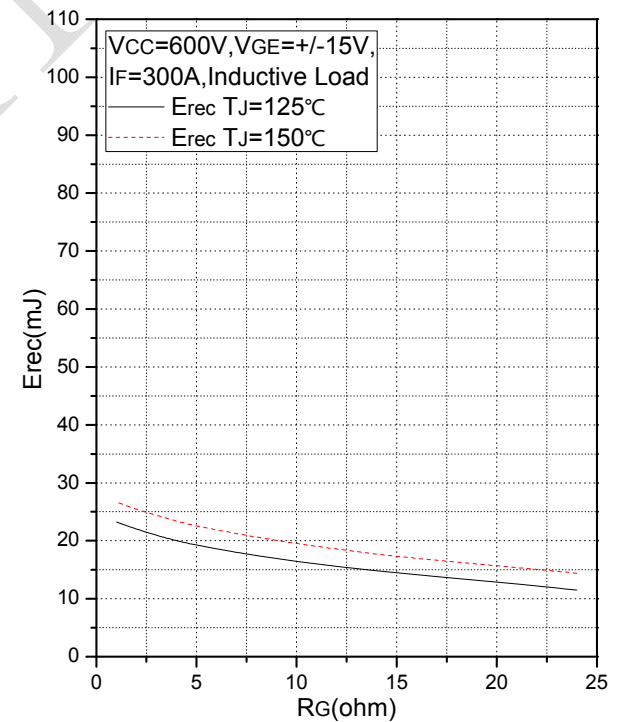

Fig.8 Typical Switching Loss vs. Gate Resistance

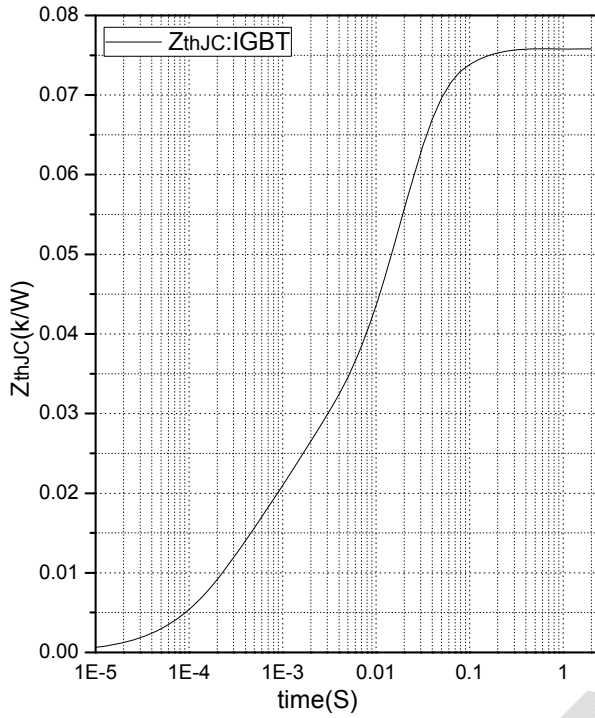

Fig.9 Transient Thermal Impedance (IGBT)

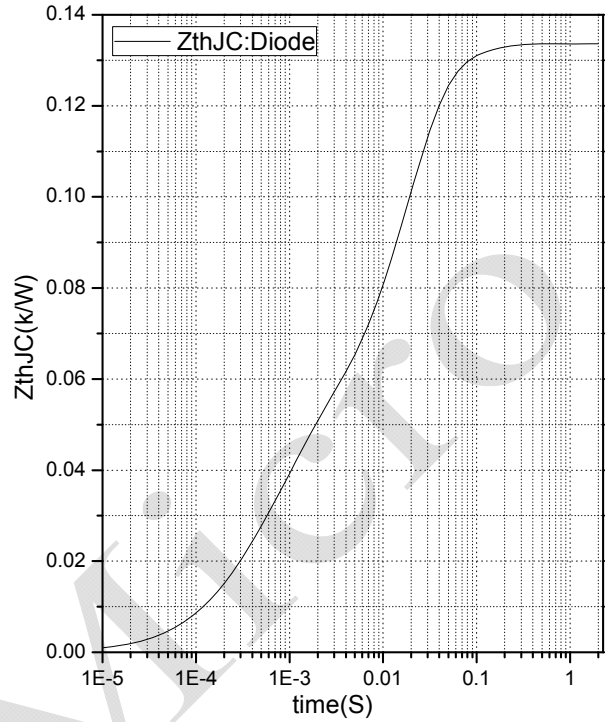
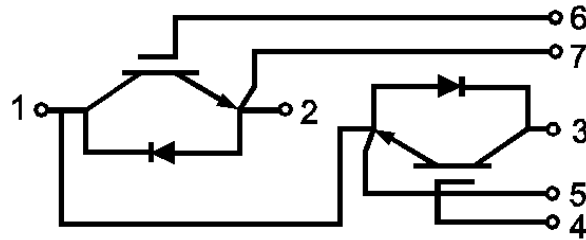
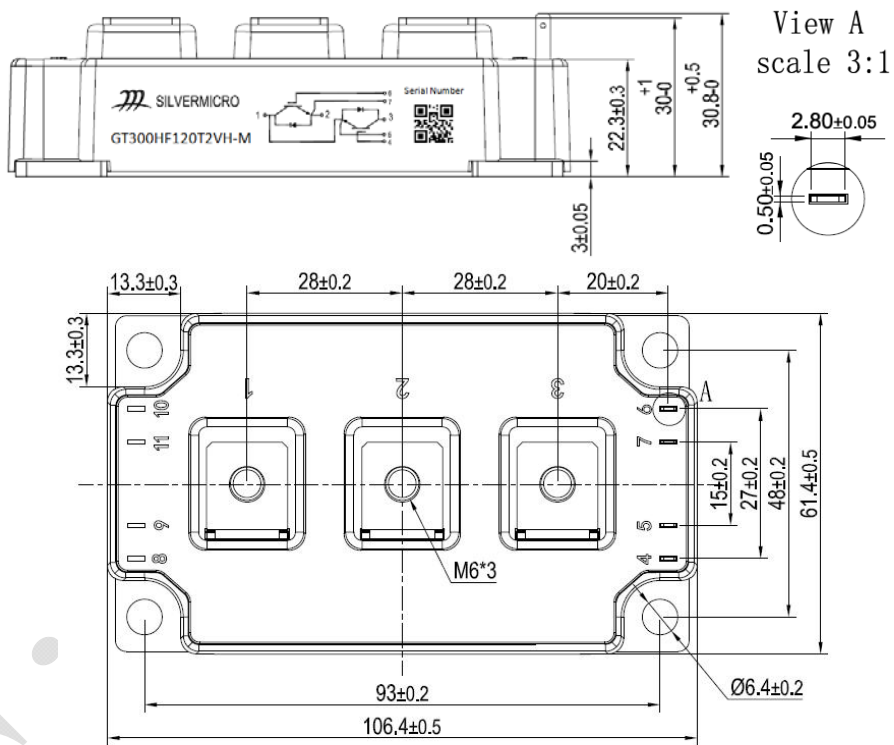

Fig.10 Transient Thermal Impedance (Diode)

### Internal Circuit



### Package Outline (Unit: mm):







Date	Revision	Notes
04/11/2018	01	Initial release
09/28/2018	A	Final Version

## Announcement

Information in this document is believed to be accurate and reliable. However, NJSME does not give any representations or warranties, expressed or implied, as to the accuracy or completeness of such information and shall have no liability for the consequences of use of such information.

## Right to Make Changes

NJSME reserves the right to make changes to information published in this document, including without limitation specifications and product descriptions, at any time and without notice. This document supersedes and replaces all information supplied prior to the publication hereof.