

GT50FF120T5H

IGBT Module

Features:

- Short Circuit Rated > 10 μ s
- Low Saturation Voltage: $V_{CE(sat)} = 1.90V @ I_C = 50A, T_C = 25^\circ C$
- Low Switching Loss
- 100% RBSOA Tested ($2 \times I_C$)
- Low Stray Inductance
- Lead Free, Compliant with RoHS Requirement

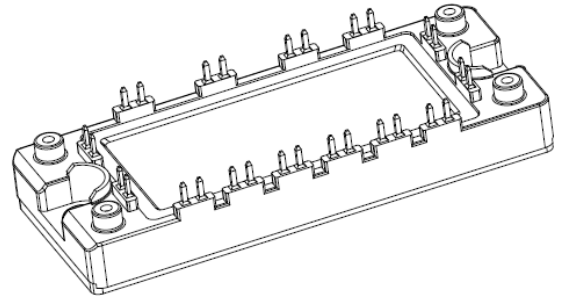

Applications:

- Industrial Inverters
- Servo Applications

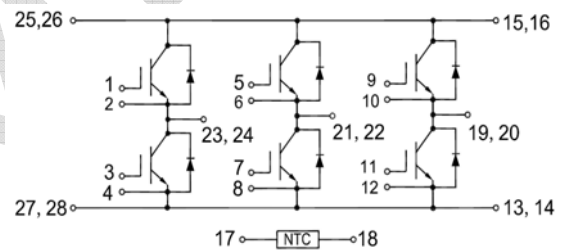

IGBT, Inverter

Maximum Rated Values ($T_C = 25^\circ C$ unless otherwise specified)

V_{CES}	Collector-Emitter Blocking Voltage		1200	V
V_{GES}	Gate-Emitter Voltage		± 20	V
I_C	Continuous Collector Current	$T_C = 80^\circ C,$	50	A
		$T_C = 25^\circ C$	100	A
I_{CM}	Peak Collector Current Repetitive	$T_J = 175^\circ C$	100	A
t_{SC}	Short Circuit Withstand Time		>10	μs
P_D	Maximum Power Dissipation per IGBT	$T_C = 25^\circ C$ $T_{Jmax} = 175^\circ C$	390	W

Electrical Characteristics of IGBT ($T_C=25^\circ\text{C}$ unless otherwise specified)

Static characteristics

Symbol	Description	Conditions	Min	Typ	Max	Unit
$V_{GE(th)}$	Gate-Emitter Threshold Voltage	$I_C = 1 \text{ mA}, V_{CE} = V_{GE}$	5.0	5.5	6.0	V
$V_{CE(sat)}$	Collector-Emitter Saturation Voltage	$I_C = 50\text{A}, V_{GE} = 15\text{V}$	$T_J = 25^\circ\text{C}$	1.90	2.20	V
			$T_J = 125^\circ\text{C}$	2.20		V
I_{CES}	Collector-Emitter Leakage Current	$V_{GE} = 0\text{V}, V_{CE} = V_{CES}, T_J = 25^\circ\text{C}$			1	mA
I_{GES}	Gate-Emitter Leakage Current	$V_{GE} = \pm 20\text{V}, V_{CE} = 0\text{V}, T_J = 25^\circ\text{C}$			100	nA
C_{ies}	Input Capacitance	$V_{CE} = 25\text{V}, V_{GE} = 0\text{V}, f = 1\text{MHz}$		6.7		nF
C_{res}	Output Capacitance			0.38		nF

Switching Characteristics

$t_{d(on)}$	Turn-on Delay Time	$V_{CC} = 600\text{V}, I_C = 50\text{A}, R_G = 15\Omega, V_{GE} = \pm 15\text{V},$ Inductive Load	$T_J = 25^\circ\text{C}$	240		ns
			$T_J = 125^\circ\text{C}$	235		
t_r	Rise Time		$T_J = 25^\circ\text{C}$	75		ns
			$T_J = 125^\circ\text{C}$	75		
$t_{d(off)}$	Turn-off Delay Time		$T_J = 25^\circ\text{C}$	235		ns
			$T_J = 125^\circ\text{C}$	250		
t_f	Fall Time		$T_J = 25^\circ\text{C}$	165		ns
			$T_J = 125^\circ\text{C}$	280		
E_{on}	Turn-on Switching Loss		$T_J = 25^\circ\text{C}$	3.72		mJ
			$T_J = 125^\circ\text{C}$	4.48		
E_{off}	Turn-off Switching Loss	$T_J = 25^\circ\text{C}$	2.25		mJ	
		$T_J = 125^\circ\text{C}$	3.54			
Q_g	Total Gate Charge	$T_J = 25^\circ\text{C}$	390		nC	
RBSOA	Reverse Bias Safe Operation Area	$I_C=100\text{A}, V_{CC}=1050\text{V}, V_p=1200\text{V}, R_g = 15\Omega, V_{GE}=\pm 15\text{V to } 0\text{V}, T_J = 150^\circ\text{C}$	Trapezoid			
SCSOA	Short Circuit Safe Operation Area	$V_{CC} = 600\text{V}, V_{GE} = 15\text{V}, T_J = 150^\circ\text{C}$	10		μs	
$R_{\theta JC}$	IGBT Thermal Resistance: Junction-To-Case			0.39	$^\circ\text{C/W}$	

Diode, Inverter
Maximum Rated Values ($T_C=25^\circ\text{C}$ unless otherwise specified)

V_{RRM}	Repetitive Peak Reverse Voltage	1200	V
I_F	Diode Continuous Forward Current	50	A
I_{FM}	Repetitive Peak Forward Current	100	A

Electrical Characteristics of FWD ($T_C=25^\circ\text{C}$ unless otherwise specified)

Symbol	Description	Conditions	Min	Typ	Max	Unit
V_{FM}	Forward Voltage	$I_F = 50\text{A}$	$T_J = 25^\circ\text{C}$	1.80	2.10	V
			$T_J = 125^\circ\text{C}$	2.00		
I_{rr}	Peak Reverse Recovery Current		$T_J = 25^\circ\text{C}$	30		A
			$T_J = 125^\circ\text{C}$	40		
Q_{rr}	Reverse Recovery Charge	$I_F=50\text{A},$ $di/dt=800\text{A}/\mu\text{s},$ $V_{rr}=600\text{V},$ $V_{GE}=-15\text{V}$	$T_J = 25^\circ\text{C}$	4.45		μC
			$T_J = 125^\circ\text{C}$	7.36		
E_{rec}	Reverse Recovery Energy		$T_J = 25^\circ\text{C}$	1.67		mJ
			$T_J = 125^\circ\text{C}$	3.07		
$R_{\theta JC}$	Diode Thermal Resistance: Junction-To-Case			0.54		$^\circ\text{C}/\text{W}$

Internal NTC-Thermistor Characteristics

R_{25}	$T_C = 25^\circ\text{C}$	5		k Ω
$\Delta R/R$	$T_C = 100^\circ\text{C}, R_{100} = 481\Omega$		± 5	%
P_{25}	$T_C = 25^\circ\text{C}$	50		mW
$B_{25/50}$	$R_2=R_{25} \exp[B_{25/50}(1/T_2-1/(298.15\text{K}))]$	3380		K
$B_{25/80}$	$R_2=R_{25} \exp[B_{25/80}(1/T_2-1/(298.15\text{K}))]$	3440		K

Module

Symbol	Description	Min	Typ	Max	Unit
V _{iso}	Isolation Voltage (All Terminals Shorted) f = 50Hz, 1minute	2500			V
T _J	Maximum Junction Temperature			175	°C
T _{JOP}	Maximum Operating Junction Temperature Range	-40		+150	°C
T _{stg}	Storage Temperature	-40		+125	°C
R _{θCS}	Case-To-Sink Thermally (Conductive Grease Applied)		0.1		°C/W
M	Mounting Screw:M5	3.0		5.0	N·m
G	Weight		200		g

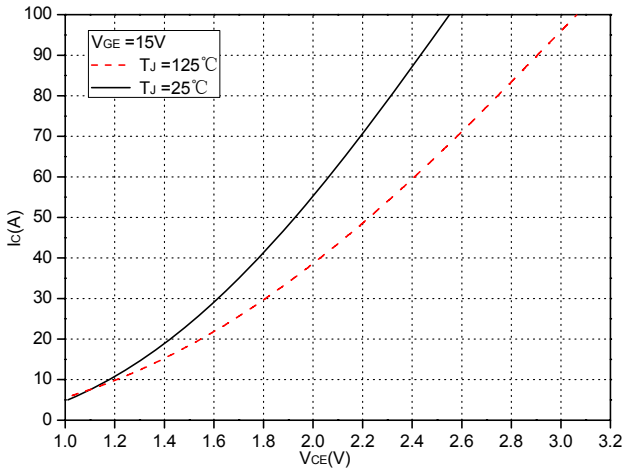

Fig.1 Typical Saturation Voltage Characteristics

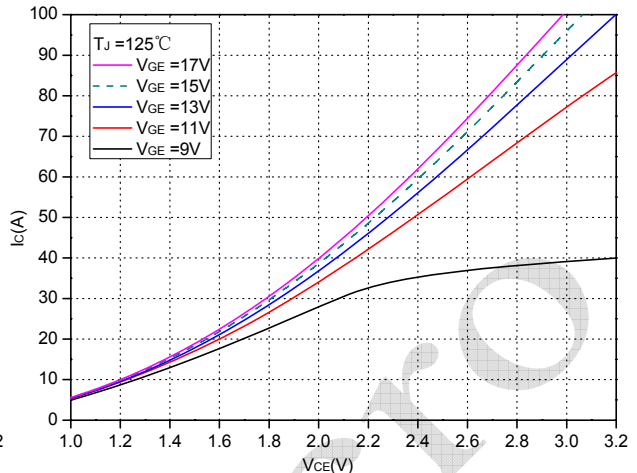

Fig.2 Typical Output Characteristics

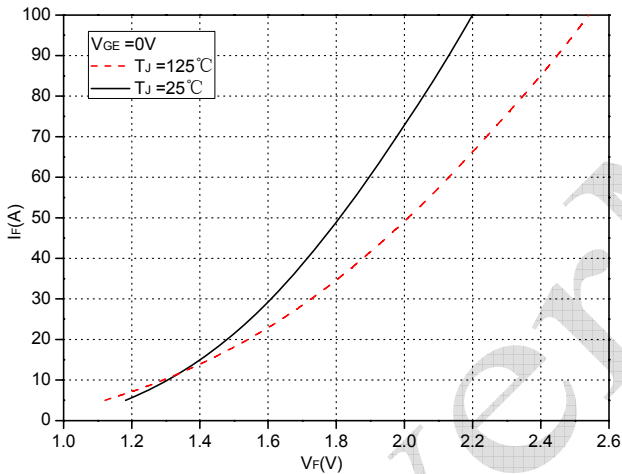

Fig.3 Forward Characteristics of FWD

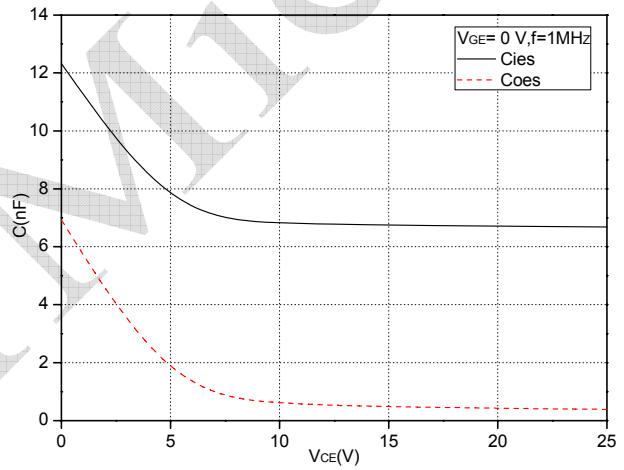

Fig.4 Capacitance Characteristics

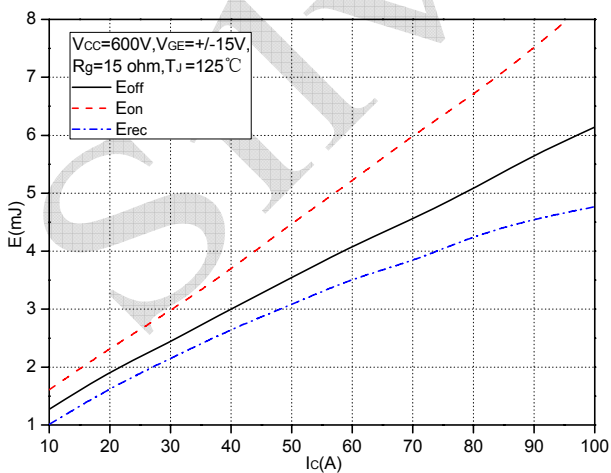

Fig.5 Typical Switching Loss vs. Collector Current

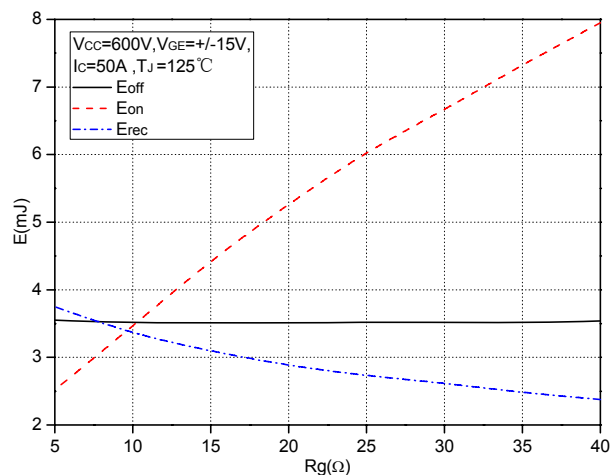

Fig.6 Typical Switching Loss vs. Gate Resistance

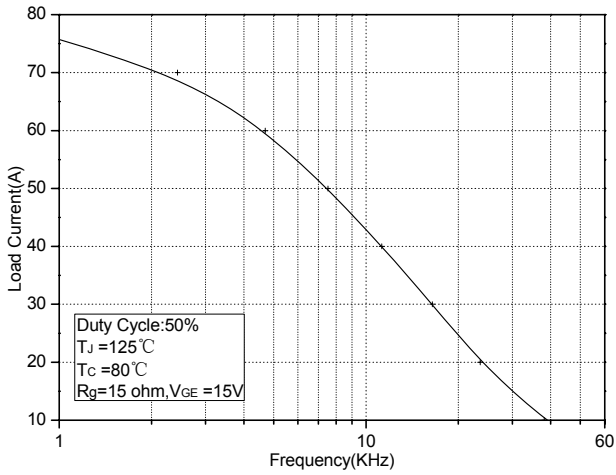

Fig.7 Typical Load Current vs. Frequency

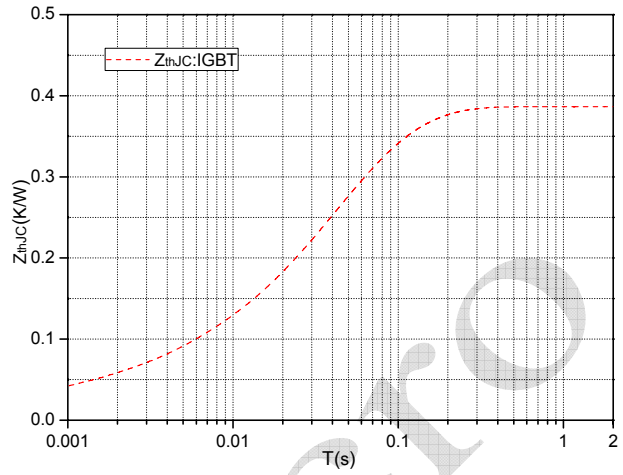

Fig.8 Transient Thermal Impedance (IGBT)

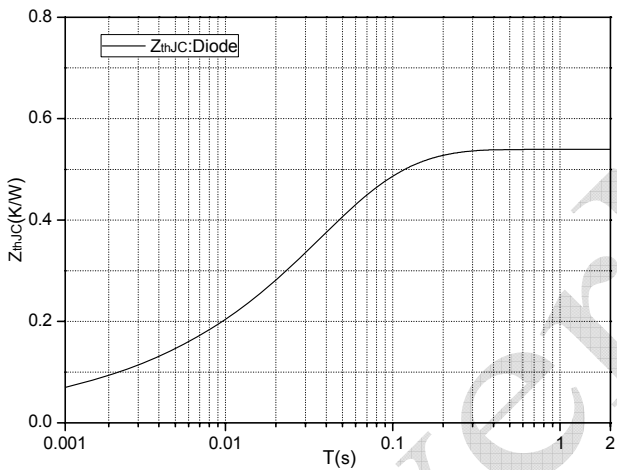

Fig.9 Transient Thermal Impedance Diode

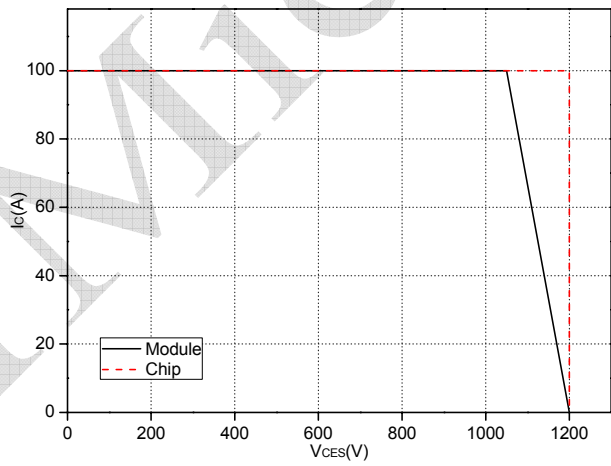

Fig.10 Reverse Bias Safe Operation Area (RBSOA)

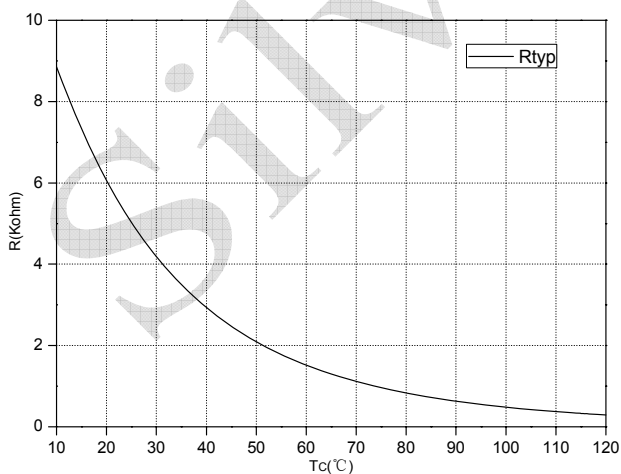
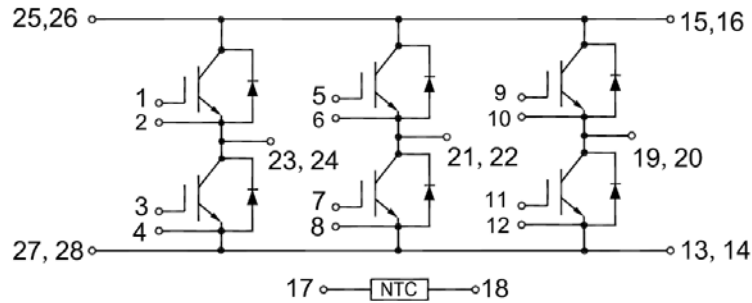
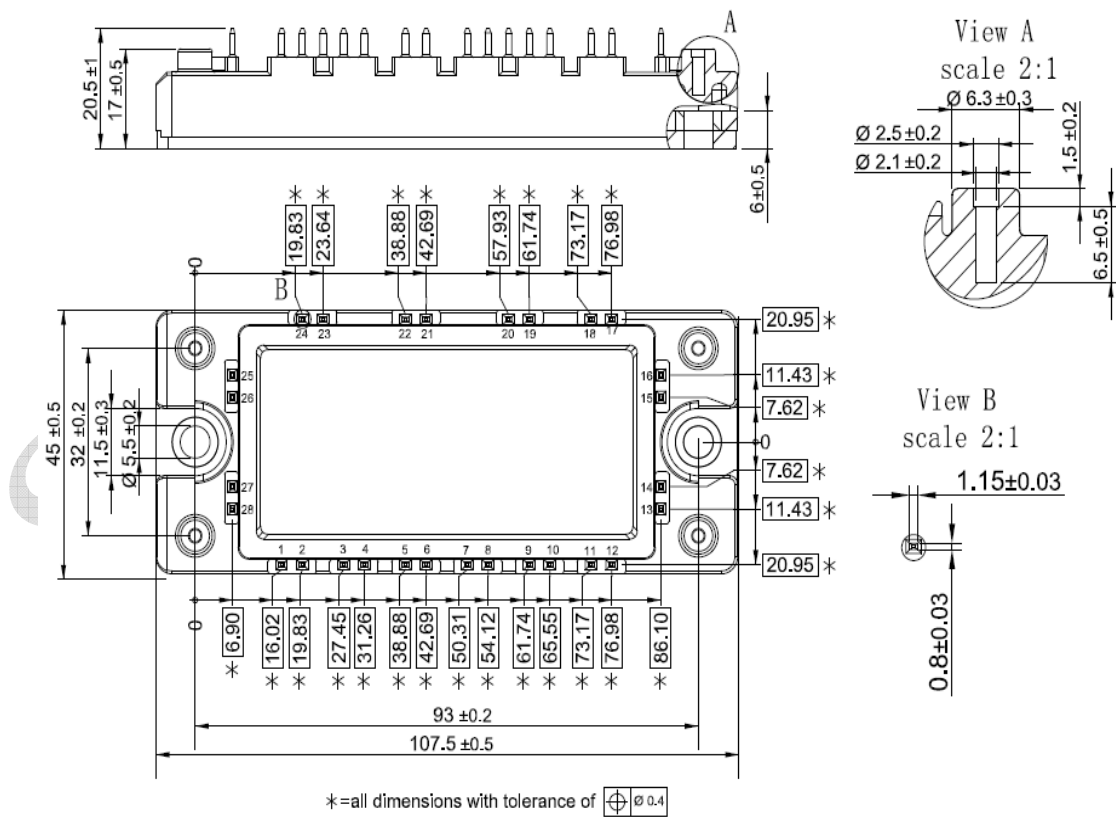
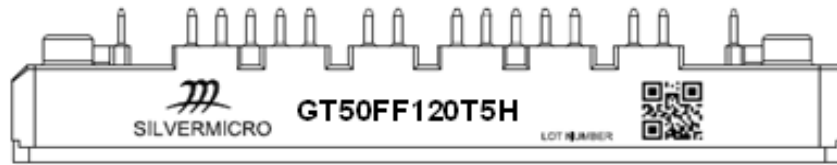

Fig.11 NTC Temperature Characteristics

Internal Circuit:



Package Outline (Unit: mm):





Date	Revision	Notes
07/07/2019	A	Final Version

Announcement

Information in this document is believed to be accurate and reliable. However, NJSME does not give any representations or warranties, expressed or implied, as to the accuracy or completeness of such information and shall have no liability for the consequences of use of such information.

Right to Make Changes

NJSME reserves the right to make changes to information published in this document, including without limitation specifications and product descriptions, at any time and without notice. This document supersedes and replaces all information supplied prior to the publication hereof.