

GT600CL120T9H-M

IGBT Module

Features:

- Trench & Field Stop IGBT
- Short Circuit Rated > 10 μ s
- Low Switching Loss
- 100% RBSOA Tested (2 \times I_c)
- Low Stray Inductance
- Copper Wire Bonding on Power Terminal
- Lead Free, Compliant with RoHS Requirement

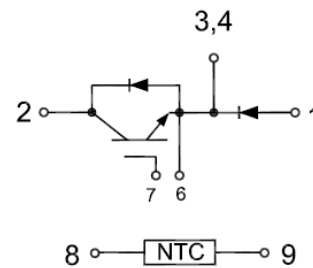

Applications:

- Hybrid Electrical Vehicles(H)EV
- Automotive Applications
- Commercial Agriculture Vehicles
- Motor Drives

IGBT, Brake-Chopper

Maximum Rated Values (T_C=25°C unless otherwise specified)

V _{CES}	Collector-Emitter Blocking Voltage		1200	V
V _{GES}	Gate-Emitter Voltage		±20	V
I _C	Continuous Collector Current	T _C =100°C	600	A
		T _C =25°C	1160	A
I _{CM}	Peak Collector Current Repetitive	T _J =175°C	1200	A
t _{SC}	Short Circuit Withstand Time		>10	μs
P _D	Maximum Power Dissipation (IGBT)	T _C =25°C T _{Jmax} =175°C	3950	W



Electrical Characteristics of Brake-chopper IGBT ($T_C=25^\circ\text{C}$ unless otherwise specified)

Static Characteristics

Symbol	Description	Conditions	Min	Typ	Max	Unit
$V_{GE(th)}$	Gate-Emitter Threshold Voltage	$I_C=10\text{mA}$, $V_{CE}=V_{GE}$	5.0	5.5	6.8	V
$V_{CE(sat)}$	Collector-Emitter Saturation Voltage	$I_C=600\text{A}$, $V_{GE}=15\text{V}$	$T_J=25^\circ\text{C}$	1.70	1.95	V
			$T_J=125^\circ\text{C}$	1.90		V
			$T_J=150^\circ\text{C}$	2.00		V
I_{CES}	Collector-Emitter Leakage Current	$V_{GE}=0\text{V}$, $V_{CE}=V_{CES}$, $T_J=25^\circ\text{C}$			1	mA
I_{GES}	Gate-Emitter Leakage Current	$V_{GE}=\pm 20\text{V}$, $V_{CE}=0\text{V}$, $T_J=25^\circ\text{C}$			800	nA
C_{ies}	Input Capacitance	$V_{CE}=25\text{V}$, $V_{GE}=0\text{V}$, $f=1\text{MHz}$		49.26		nF
C_{oes}	Output Capacitance			3.67		nF
C_{res}	Reverse Transfer Capacitance			1.85		nF

Switching Characteristics

$t_{d(on)}$	Turn-on Delay Time	$V_{CC}=600\text{V}$, $I_C=600\text{A}$, $R_{Gon}=1\Omega$, $V_{GE}=\pm 15\text{V}$, Inductive Load	$T_J=25^\circ\text{C}$	0.55		μs
			$T_J=125^\circ\text{C}$	0.56		
			$T_J=150^\circ\text{C}$	0.56		
t_r	Rise Time		$T_J=25^\circ\text{C}$	0.22		μs
			$T_J=125^\circ\text{C}$	0.22		
			$T_J=150^\circ\text{C}$	0.23		
$t_{d(off)}$	Turn-off Delay Time		$T_J=25^\circ\text{C}$	0.54		μs
			$T_J=125^\circ\text{C}$	0.57		
			$T_J=150^\circ\text{C}$	0.57		
t_f	Fall Time	$T_J=25^\circ\text{C}$	0.14		μs	
		$T_J=125^\circ\text{C}$	0.18			
		$T_J=150^\circ\text{C}$	0.19			
E_{on}	Turn-on Switching Loss	$V_{CC}=600\text{V}$, $I_C=600\text{A}$, $R_{Gon}=1\Omega$, $V_{GE}=\pm 15\text{V}$, $di/dt=2120\text{A}/\mu\text{s}$ ($T_J=150^\circ\text{C}$) Inductive Load	$T_J=25^\circ\text{C}$	49.0		mJ
		$T_J=125^\circ\text{C}$	75.8			
		$T_J=150^\circ\text{C}$	81.2			

E _{off}	Turn-off Switching Loss	V _{CC} =600V, I _C =600A, R _{Goff} =1Ω, V _{GE} = ±15V, du/dt=2600V/μs (T _J =150°C) Inductive Load	T _J =25°C	81.5	mJ
			T _J =125°C	96.1	
			T _J =150°C	100.1	
Q _g	Total Gate Charge	V _{GE} =+15V...-15V	T _J =25°C	3.36	μC
R _{g internal}	Internal Gate Resistance		T _J =25°C	1.1	Ω
RBSOA	I _C =1200A, V _{CC} =1050V, V _p =1200V, R _{Goff} = 1Ω, V _{GE} =+15V to 0V, T _J =150°C			Trapezoid	
SCSOA	V _{CC} =600V, V _{GE} =15V, T _J =150°C			10	μs
R _{θJC}	IGBT Thermal Resistance: Junction-To-Case(per leg)			0.038	°C/W

Diode, Reverse

Maximum Rated Values of Reverse Diode (T_C=25°C unless otherwise specified)

V _{RRM}	Repetitive Peak Reverse Voltage	1200	V
I _F	Diode Continuous Forward Current	450	A
I _{FM}	Diode Maximum Forward Current	900	A

Electrical Characteristics of Reverse Diode (T_C=25°C unless otherwise specified)

Symbol	Description	Conditions	Min	Typ	Max	Unit
V _{FM}	Forward Voltage	I _F =450A	T _J =25°C	1.50		V
			T _J =125°C	1.50		
			T _J =150°C	1.50		
t _{rr}	Reverse Recovery Time	I _F =450A, -diF/dt=2610A/μs(T _J =150°C), V _R =600V, V _{GE} =-15V	T _J =25°C	0.45		μs
			T _J =125°C	0.65		
			T _J =150°C	0.74		
I _{rr}	Peak Reverse Recovery Current	I _F =450A, -diF/dt=2610A/μs(T _J =150°C), V _R =600V, V _{GE} =-15V	T _J =25°C	305		A
			T _J =125°C	352		
			T _J =150°C	366		



Q _{rr}	Reverse Recovery Charge	I _F =450A, -diF/dt=2610A/μs(T _J =150°C), V _R =600V, V _{GE} =-15V	T _J =25°C	72	μC
			T _J =125°C	114	
			T _J =150°C	132	
E _{rec}	Reverse Recovery Energy	I _F =450A, -diF/dt=2610A/μs(T _J =150°C), V _R =600V, V _{GE} =-15V	T _J =25°C	35.1	mJ
			T _J =125°C	56.3	
			T _J =150°C	64.7	
R _{θJC}	Diode Thermal Resistance: Junction-To-Case (per leg)			0.097	°C/W

Diode, Brake -Chopper

Maximum Rated Values of Brake-Chopper Diode (T_C=25°C unless otherwise specified)

V _{RRM}	Repetitive Peak Reverse Voltage	1200	V
I _F	Diode Continuous Forward Current	600	A
I _{FM}	Diode Maximum Forward Current	1200	A

Electrical Characteristics of Brake-Chopper Diode (T_C=25°C unless otherwise specified)

Symbol	Description	Conditions	Min	Typ	Max	Unit
V _{FM}	Forward Voltage	I _F =600A	T _J =25°C	1.80	2.00	V
			T _J =125°C	1.90		
			T _J =150°C	1.90		
t _{rr}	Reverse Recovery Time	I _F =600A, -diF/dt=2270A/μs(T _J =150°C), V _R =600V, V _{GE} =-15V	T _J =25°C	0.37		μs
			T _J =125°C	0.58		
			T _J =150°C	0.65		
I _{rr}	Peak Reverse Recovery Current	I _F =600A, -diF/dt=2270A/μs(T _J =150°C), V _R =600V, V _{GE} =-15V	T _J =25°C	238		A
			T _J =125°C	294		
			T _J =150°C	306		
Q _{rr}	Reverse Recovery Charge	I _F =600A, -diF/dt=2270A/μs(T _J =150°C), V _R =600V, V _{GE} =-15V	T _J =25°C	52.3		μC
			T _J =125°C	96.1		
			T _J =150°C	110.6		



E _{rec}	Reverse Recovery Energy	I _F =600A, -diF/dt=2270A/μs(T _J =150°C), V _R =600V, V _{GE} =-15V	T _J =25°C	22.0	mJ
			T _J =125°C	38.3	
			T _J =150°C	44.6	
R _{θJC}	Diode Thermal Resistance: Junction-To-Case (per leg)			0.064	°C/W

Internal NTC-Thermistor Characteristics

R ₂₅	T _C =25°C	5		kΩ
ΔR/R	T _C =100°C, R ₁₀₀ =481Ω		±5	%
P ₂₅	T _C =25°C	50		mW
B _{25/50}	R ₂ =R ₂₅ exp[B _{25/50} (1/T ₂ -1/(298.15K))]	3380		K
B _{25/80}	R ₂ =R ₂₅ exp[B _{25/80} (1/T ₂ -1/(298.15K))]	3440		K

Module

Symbol	Description	Min	Typ	Max	Unit
V _{iso}	Isolation Voltage (All Terminals Shorted)	f = 50Hz, 1minute	2500		V
L _{sCE}	Stray Inductance Module			20	nH
T _J	Maximum Junction Temperature			175	°C
T _{JOP}	Maximum Operating Junction Temperature Range		-40	+150	°C
T _{stg}	Storage Temperature		-40	+125	°C
CTI	Comparative Tracking Index		200		
R _{θCS}	Case-To-Sink Thermally (Conductive Grease Applied)			0.02	°C/W
M	Power Terminals Screw:M5		3.0	5.0	N·m
M	Mounting Screw:M6		4.0	6.0	N·m
G	Weight			330	g

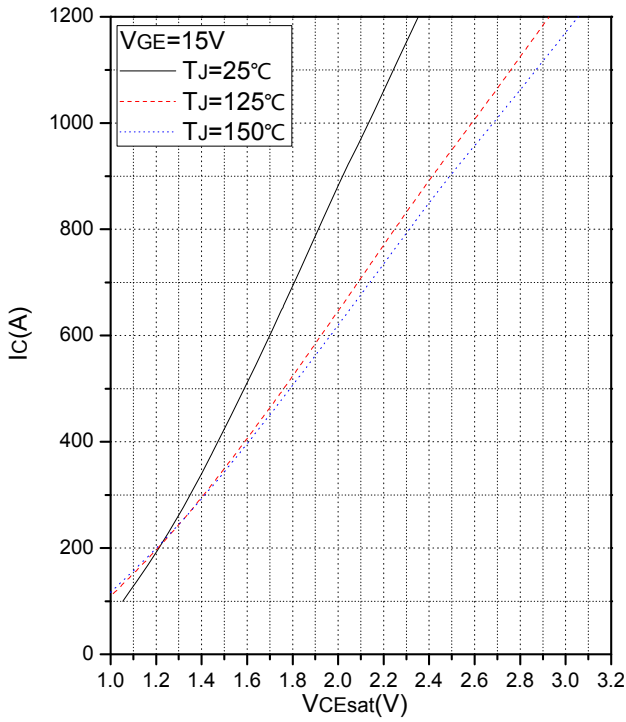

Fig.1 Typical Saturation Voltage Characteristics

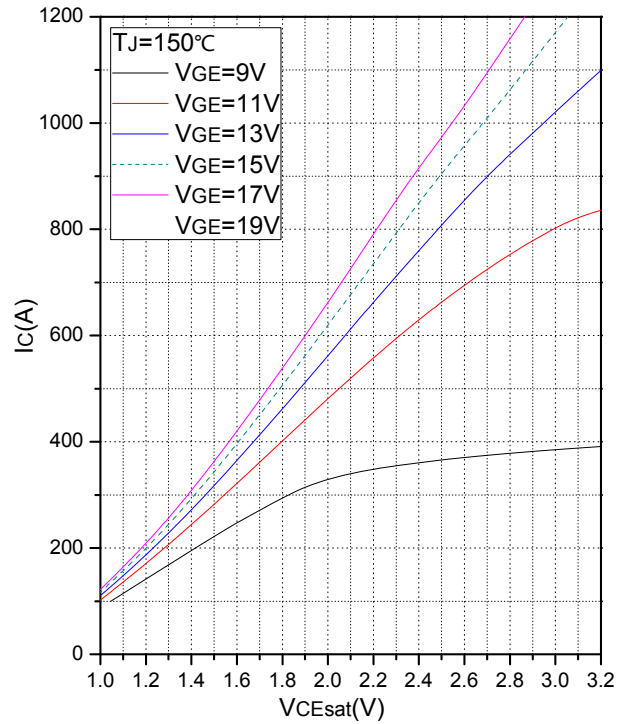

Fig.2 Typical Output Characteristics

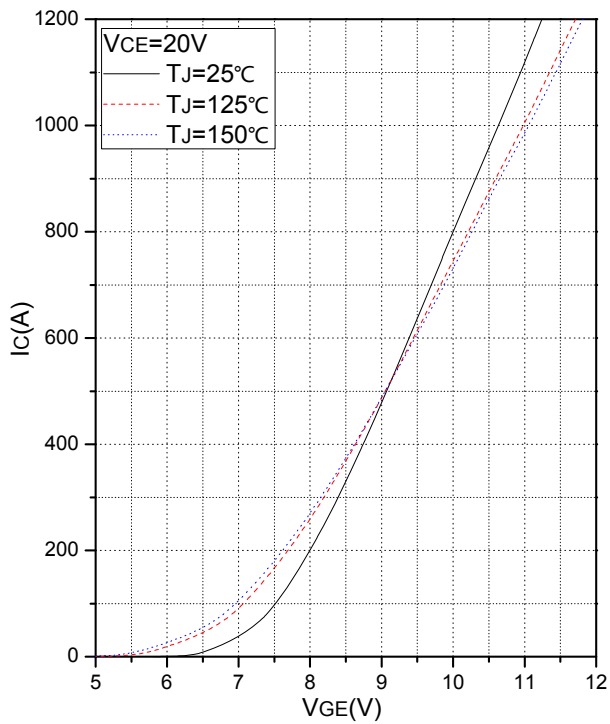

Fig.3 Transfer Characteristic

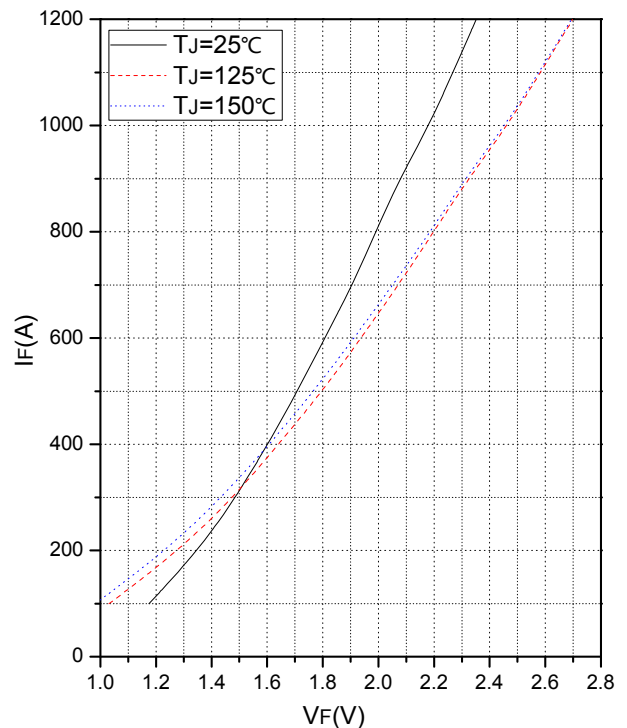

Fig.4 Forward Characteristics of Brake-Chopper Diode

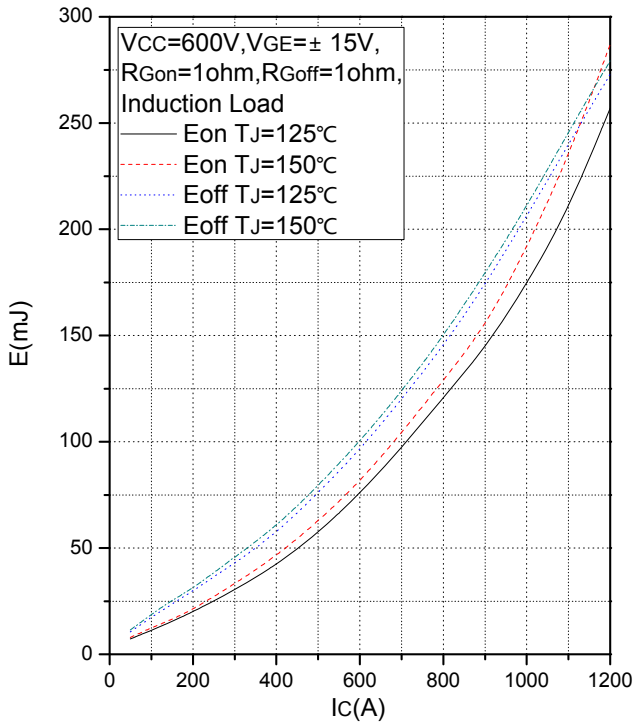

Fig.5 Typical Switching Loss vs. Collector Current

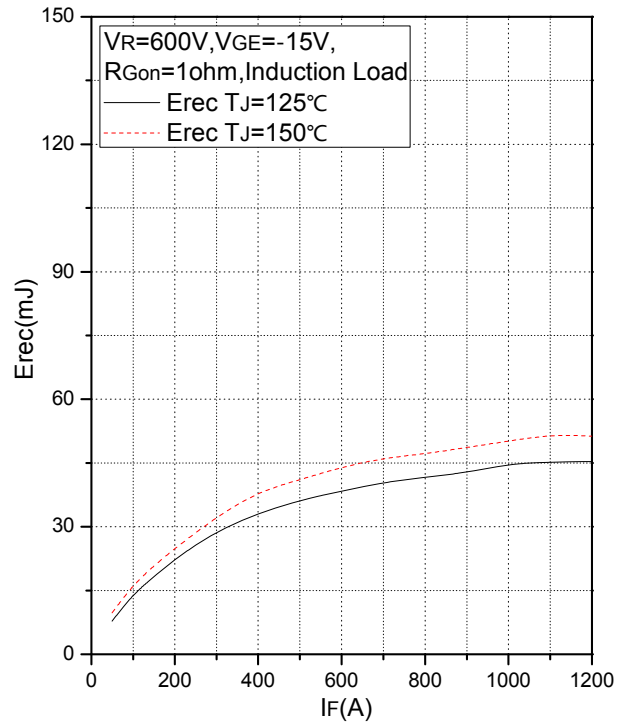

Fig.6 Typical Switching Loss vs. Forward Current

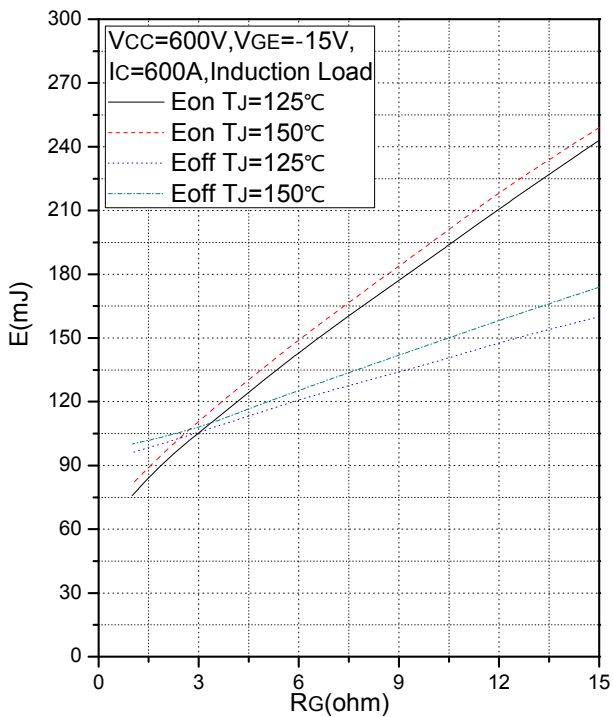

Fig.7 Typical Switching Loss vs. Gate Resistance

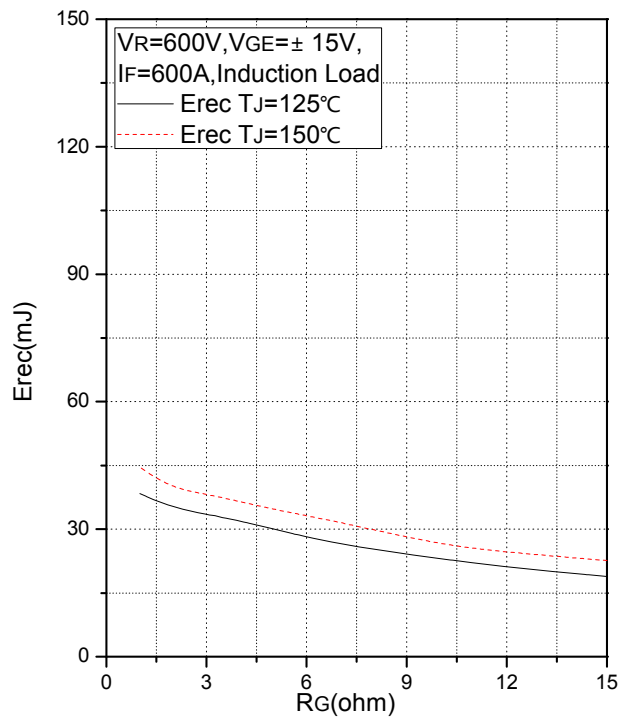

Fig.8 Typical Switching Loss vs. Gate Resistance

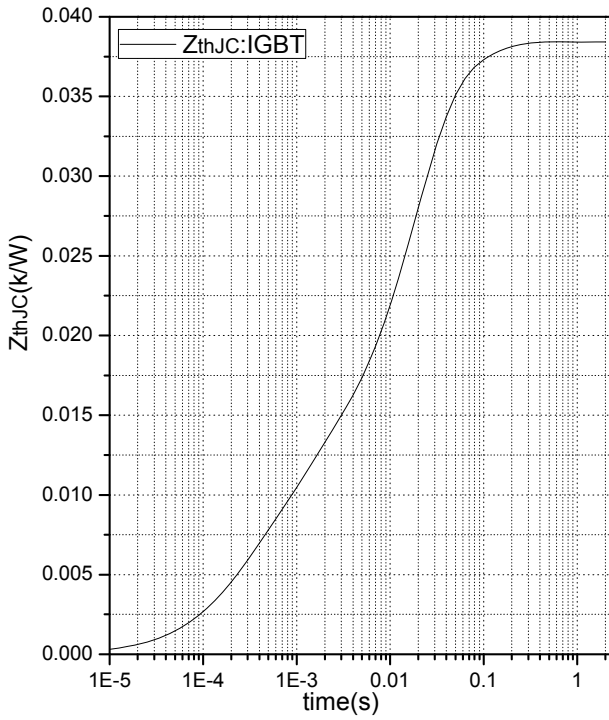

Fig.9 Transient Thermal Impedance (IGBT)

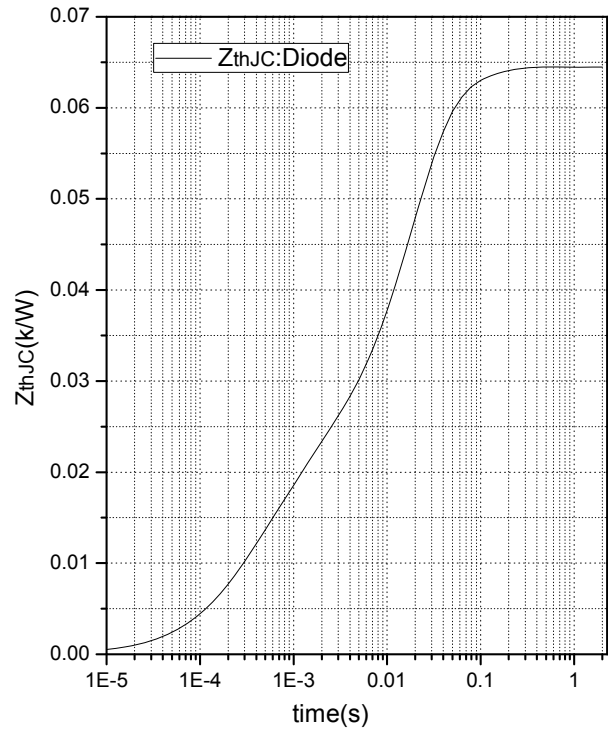

Fig.10 Transient Thermal Impedance (Brake-Chopper Diode)

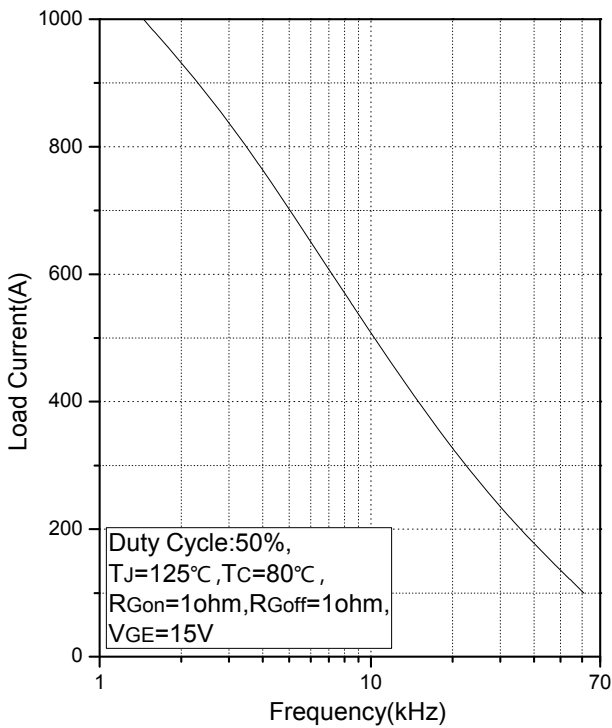

Fig.11 Typical Load Current vs. Frequency

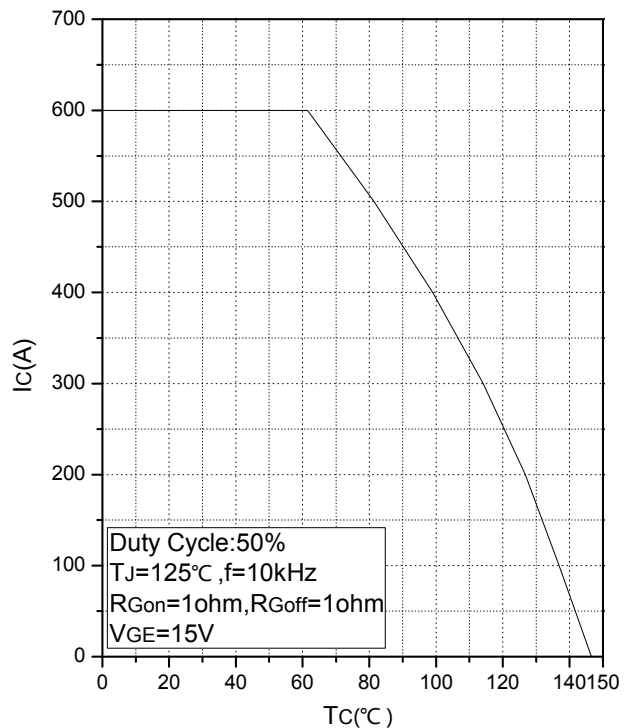

Fig.12 Rated Current vs. Temperature

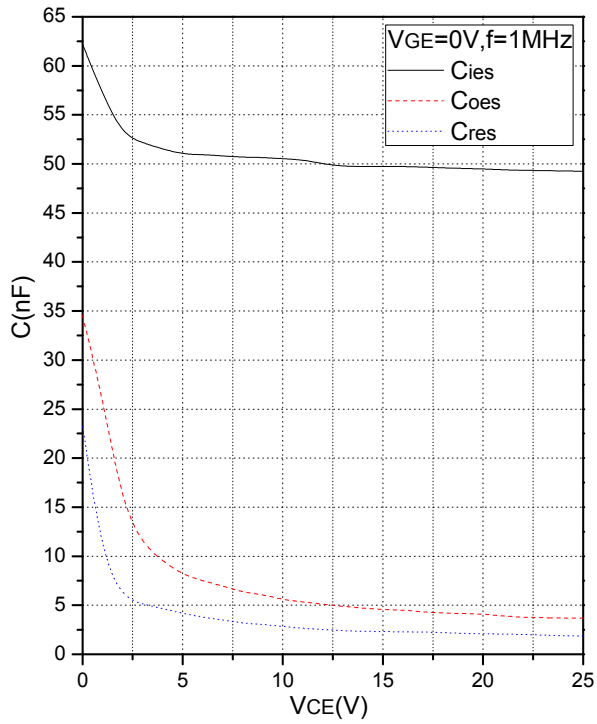

Fig. 13 Capacitance Characteristics

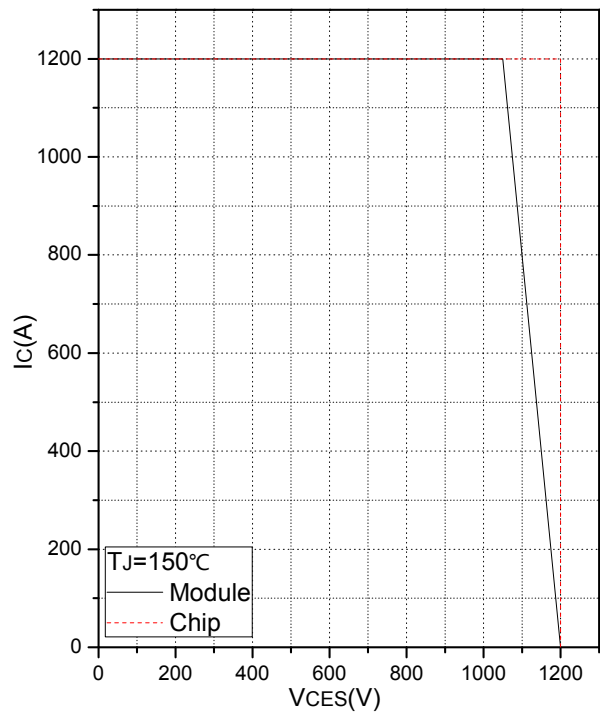

Fig. 14 Reverse Bias Safe Operation Area (RBSOA)

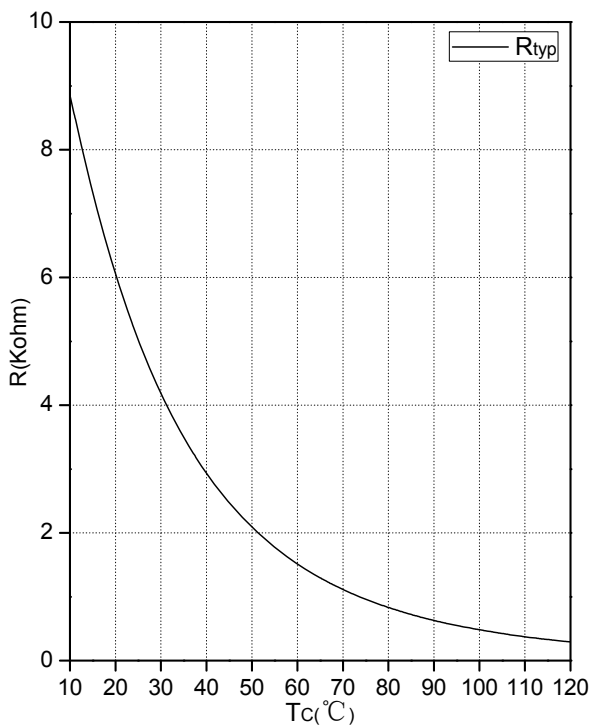

Fig. 15 NTC Temperature Characteristics

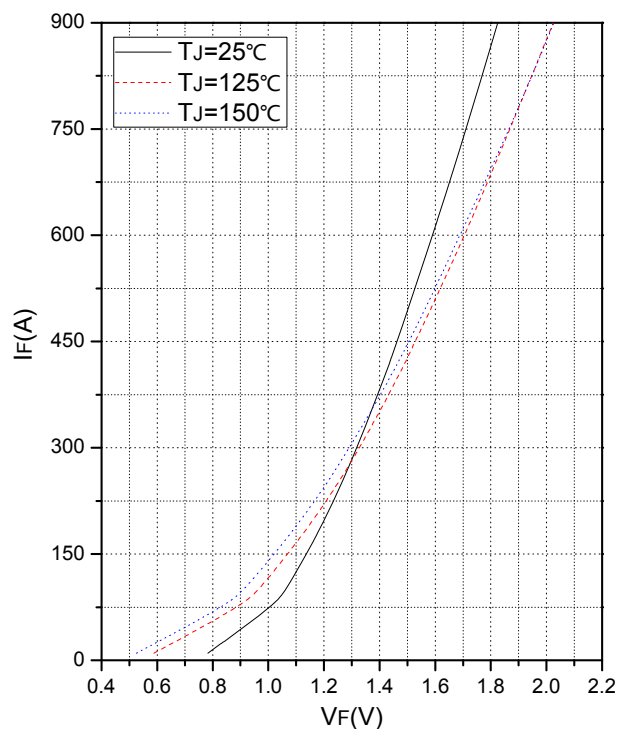
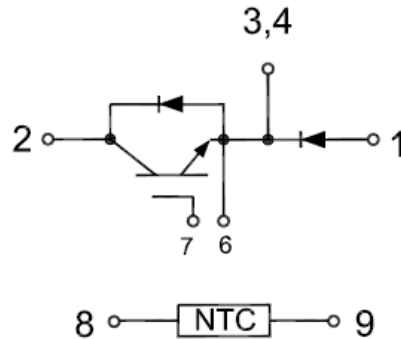
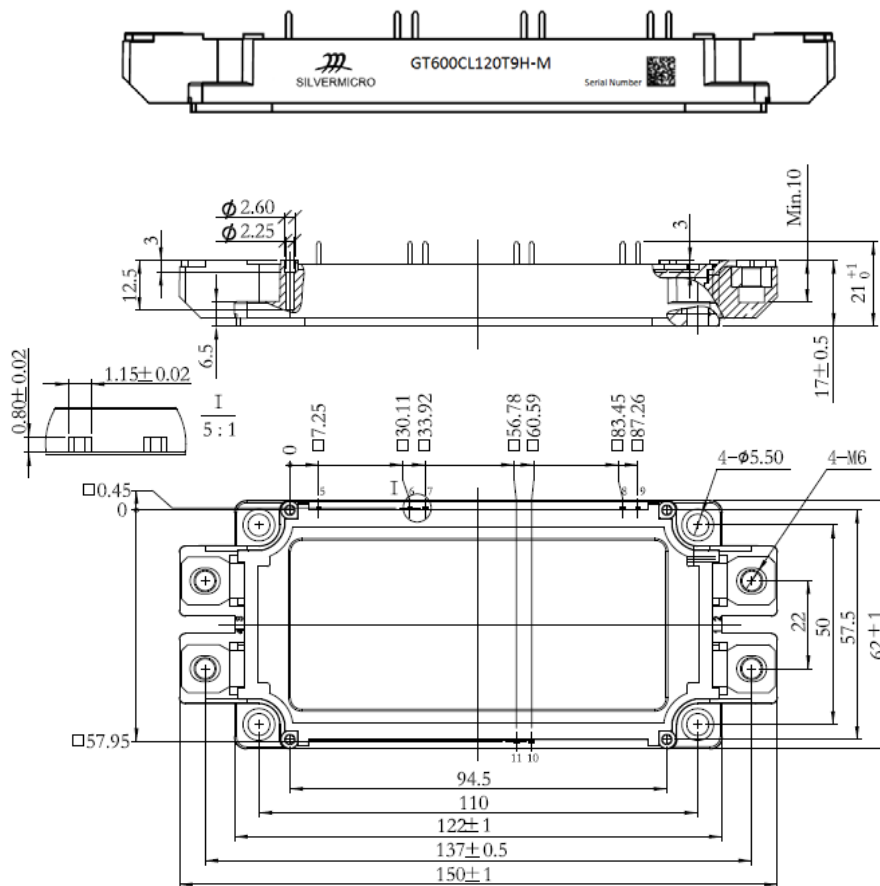

Fig. 16 Forward Characteristics of Reverse Diode

Internal Circuit:



Package Outline (Unit: mm):





Date	Revision	Notes
05/21/2019	A	Final Version

Announcement

Information in this document is believed to be accurate and reliable. However, NJSME does not give any representations or warranties, expressed or implied, as to the accuracy or completeness of such information and shall have no liability for the consequences of use of such information.

Right to Make Changes

NJSME reserves the right to make changes to information published in this document, including without limitation specifications and product descriptions, at any time and without notice. This document supersedes and replaces all information supplied prior to the publication hereof.