

GT75HF120T1VH-M

IGBT Module

Preliminary Data

Features:

- Field Stop Trench Gate IGBT
- Short Circuit Rated >10 μ s
- Low Saturation Voltage
- Low Switching Loss
- 100% RBSOA Tested (2 \times I_c)
- Low Stray Inductance
- Lead Free, Compliant with RoHS Requirement

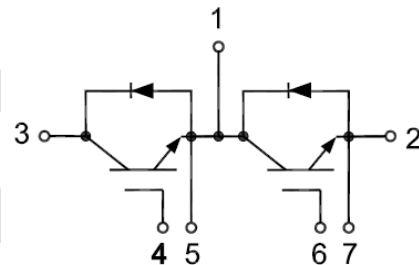

Applications:

- Welding Machine, Cutting Machine
- Plating Power Supply, Induction Heating
- SMPS, UPS

Maximum Rated Values of IGBT (T_C=25°C unless otherwise specified)

V _{CES}	Collector-Emitter Blocking Voltage		1200	V
V _{GES}	Gate-Emitter Voltage		±20	V
I _C	Continuous Collector Current	T _C = 100°C	75	A
		T _C = 25°C	150	A
I _{CM}	Repetitive Peak Collector Current	T _J = 175°C	150	A
t _{SC}	Short Circuit Withstand Time		>10	μs
P _D	Maximum Power Dissipation per IGBT	T _C = 25°C T _{Jmax} = 175°C	540	W

Electrical Characteristics of IGBT ($T_C=25^\circ\text{C}$ unless otherwise specified)

Static Characteristics

Symbol	Description	Conditions	Min	Typ	Max	Unit
$V_{GE(th)}$	Gate-Emitter Threshold Voltage	$I_C = 2.6\text{mA}, V_{CE} = V_{GE}$	5.0	5.5	6.6	V
$V_{CE(sat)}$	Collector-Emitter Saturation Voltage	$I_C = 75\text{A}, V_{GE} = 15\text{V}$	$T_J = 25^\circ\text{C}$	1.60	1.90	V
			$T_J = 125^\circ\text{C}$	1.80		V
I_{CES}	Collector-Emitter Leakage Current	$V_{GE} = 0\text{V}, V_{CE} = V_{CES}, T_J = 25^\circ\text{C}$			1	mA
I_{GES}	Gate-Emitter Leakage Current	$V_{GE} = \pm 20\text{V}, V_{CE} = 0\text{V}, T_J = 25^\circ\text{C}$			400	nA
C_{ies}	Input Capacitance			5.62		nF
C_{oes}	Output Capacitance	$V_{CE} = 25\text{V}, V_{GE} = 0\text{V}, f = 1\text{MHz}$		0.49		nF
C_{res}	Reverse Transfer Capacitance			0.38		nF

Switching Characteristics

$t_{d(on)}$	Turn-on Delay Time	$V_{CC} = 600\text{V}, I_C = 75\text{A}, R_{Gon} = 2\Omega, V_{GE} = \pm 15\text{V},$ Inductive Load	$T_J = 25^\circ\text{C}$		158		ns
			$T_J = 125^\circ\text{C}$		163		
t_r	Rise Time	$V_{CC} = 600\text{V}, I_C = 75\text{A}, R_{Gon} = 2\Omega, V_{GE} = \pm 15\text{V},$ Inductive Load	$T_J = 25^\circ\text{C}$		49		ns
			$T_J = 125^\circ\text{C}$		53		
$t_{d(off)}$	Turn-off Delay Time	$V_{CC} = 600\text{V}, I_C = 75\text{A}, R_{Goff} = 2\Omega, V_{GE} = \pm 15\text{V},$ Inductive Load	$T_J = 25^\circ\text{C}$		193		ns
			$T_J = 125^\circ\text{C}$		211		
t_f	Fall Time	$V_{CC} = 600\text{V}, I_C = 75\text{A}, R_{Goff} = 2\Omega, V_{GE} = \pm 15\text{V},$ Inductive Load	$T_J = 25^\circ\text{C}$		203		ns
			$T_J = 125^\circ\text{C}$		370		
E_{on}	Turn-on Switching Loss	$V_{CC} = 600\text{V}, I_C = 75\text{A}, R_{Gon} = 2\Omega, V_{GE} = \pm 15\text{V},$ $di/dt = 1203\text{A}/\mu\text{s} (T_J = 125^\circ\text{C}),$ Inductive Load	$T_J = 25^\circ\text{C}$		3.22		mJ
			$T_J = 125^\circ\text{C}$		4.35		
E_{off}	Turn-off Switching Loss	$V_{CC} = 600\text{V}, I_C = 75\text{A}, R_{Goff} = 2\Omega, V_{GE} = \pm 15\text{V},$ $du/dt = 4109\text{A}/\mu\text{s} (T_J = 125^\circ\text{C}),$ Inductive Load	$T_J = 25^\circ\text{C}$		3.40		mJ
			$T_J = 125^\circ\text{C}$		5.91		
Q_g	Total Gate Charge	$V_{GE} = +15\text{V} \dots -15\text{V}$	$T_J = 25^\circ\text{C}$		374		nC
R_{gint}	Internal Gate Resistor		$T_J = 25^\circ\text{C}$		10		Ω
RBSOA	Reverse Bias Safe Operation Area	$I_C = 150\text{A}, V_{CC} = 1050\text{V}, V_p = 1200\text{V},$ $R_{Goff} = 2\Omega, V_{GE} = +15\text{V to } 0\text{V}, T_J = 150^\circ\text{C}$	Trapezoid				
SC Data	$V_{CC} = 800\text{V}, t_p = 10\mu\text{s}, V_{GE} = \pm 15\text{V}, R_{Gon} = 10\text{ohm}, R_{Goff} = 10\text{ohm}, T_J = 25^\circ\text{C}$				469		A
$R_{\theta JC}$	IGBT Thermal Resistance: Junction-To-Case				0.277		$^\circ\text{C}/\text{W}$

Maximum Rated Values of Diode ($T_C=25^\circ\text{C}$ unless otherwise specified)

V_{RRM}	Repetitive Peak Reverse Voltage	1200	V
I_F	Diode Continuous Forward Current	75	A
I_{FM}	Diode Maximum Forward Current	150	A

Electrical Characteristics of Diode ($T_C=25^\circ\text{C}$ unless otherwise specified)

Symbol	Description	Conditions	Min	Typ	Max	Unit	
V_{FM}	Forward Voltage	$I_F = 75\text{A}$	$T_J=25^\circ\text{C}$	2.10		V	
			$T_J=125^\circ\text{C}$	2.20			
t_{rr}	Reverse Recovery Time	$I_F = 75\text{A}$, $-di_F/dt = 1738\text{A}/\mu\text{s}$ ($T_J=125^\circ\text{C}$), $V_R = 600\text{V}$, $V_{GE} = -15\text{V}$	$T_J=25^\circ\text{C}$	204		ns	
			$T_J=125^\circ\text{C}$	388			
I_{rr}	Peak Reverse Recovery Current		$T_J=25^\circ\text{C}$	47		A	
			$T_J=125^\circ\text{C}$	64			
Q_{rr}	Reverse Recovery Charge		$T_J=25^\circ\text{C}$	4.56		μC	
			$T_J=125^\circ\text{C}$	9.42			
E_{rec}	Reverse Recovery Energy		$T_J=25^\circ\text{C}$	1.67		mJ	
			$T_J=125^\circ\text{C}$	3.60			
$R_{\theta JC}$	Diode Thermal Resistance: Junction-To-Case			0.425		$^\circ\text{C}/\text{W}$	

Module

Symbol	Description		Min	Typ	Max	Unit
V _{iso}	Isolation Voltage (All Terminals Shorted)	f = 50Hz, 1minute	2500			V
T _J	Maximum Junction Temperature				175	°C
T _{JOP}	Maximum Operating Junction Temperature Range		-40		+150	°C
T _{stg}	Storage Temperature		-40		+125	°C
CTI	Comparative Tracking Index		200			V
R _{eCS}	Case-To-Sink Thermally (Conductive Grease Applied)			0.1		°C/W
T	Power Terminals Screw:M5		3.0		5.0	N·m
T	Mounting Screw:M6		4.0		6.0	N·m
G	Weight			165		g

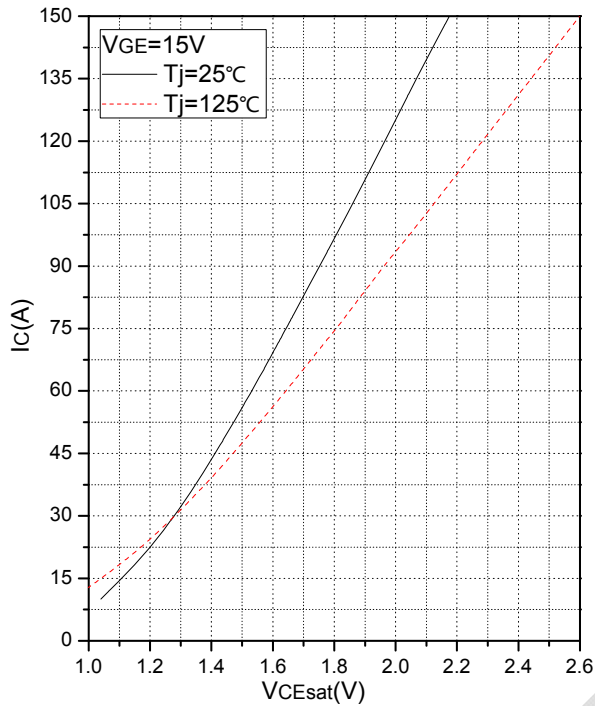

Fig.1 Typical Saturation Voltage Characteristics

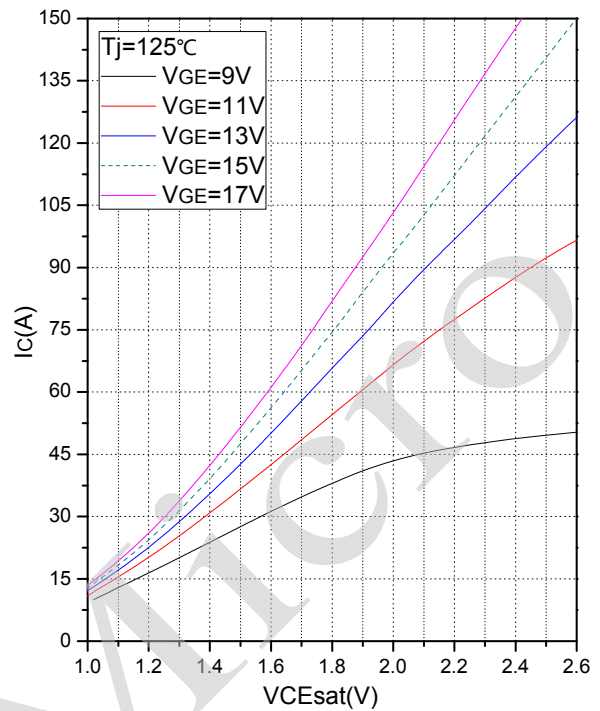

Fig.2 Typical Output Characteristics

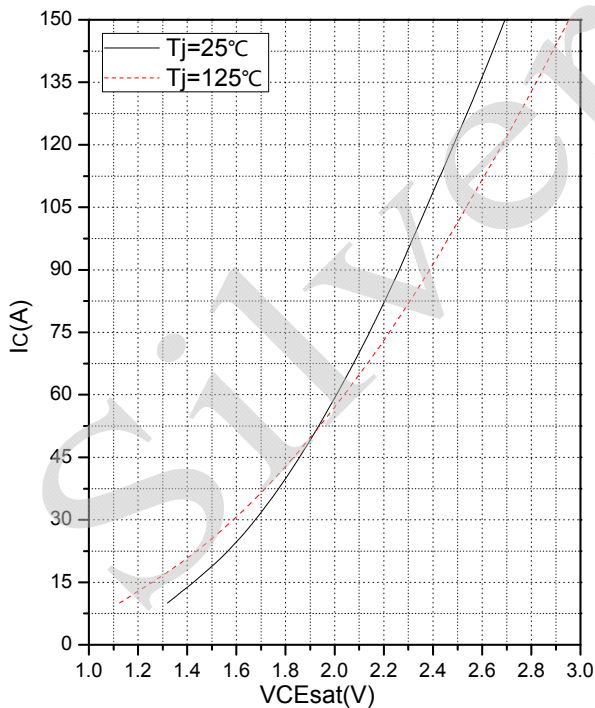

Fig.3 Forward Characteristics of Diode

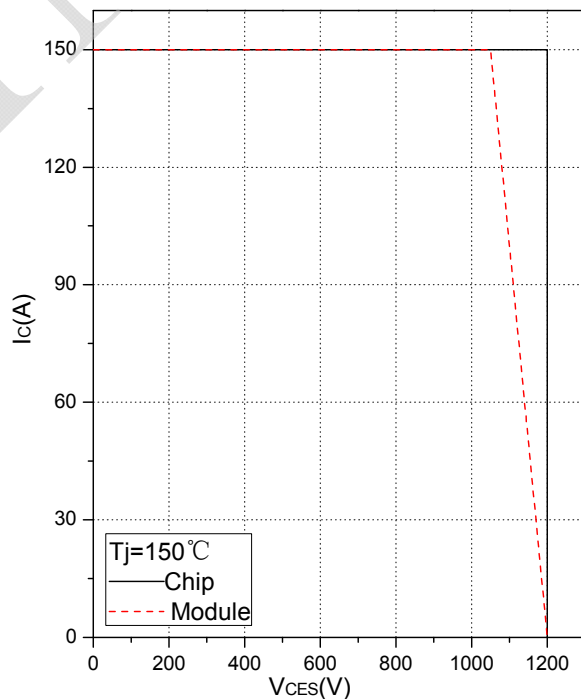

Fig.4 Reverse Bias Safe Operation Area (RBSOA)

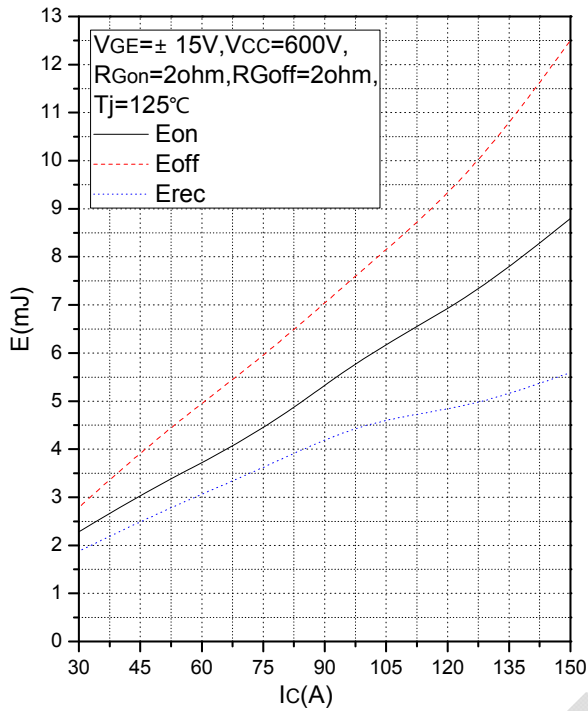

Fig.5 Typical Switching Loss vs. Collector Current

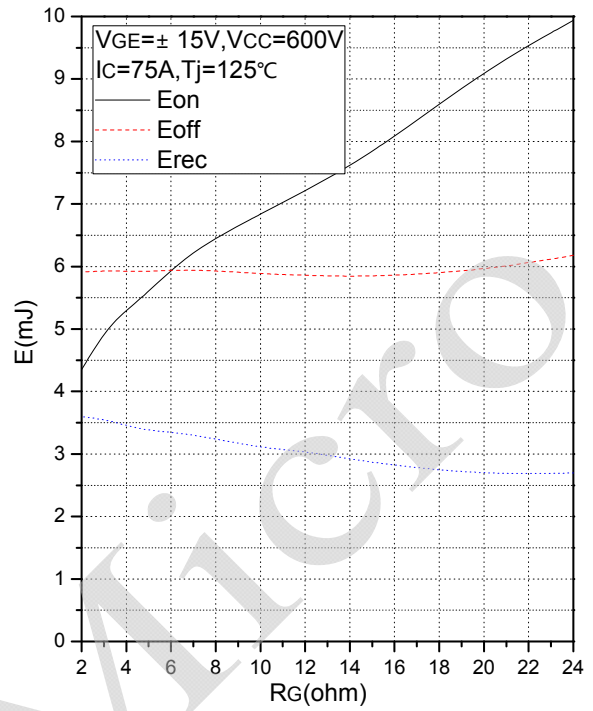

Fig.6 Typical Switching Loss vs. Gate Resistance

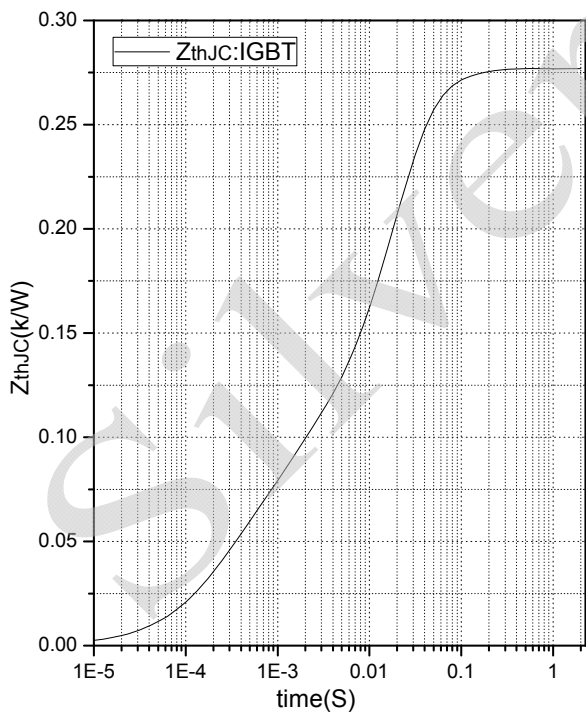

Fig.7 Transient Thermal Impedance (IGBT)

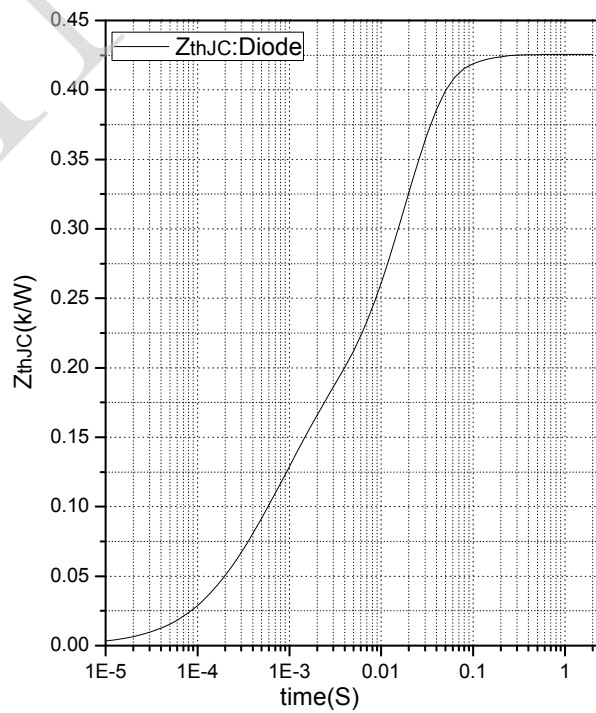

Fig.8 Transient Thermal Impedance (Diode)

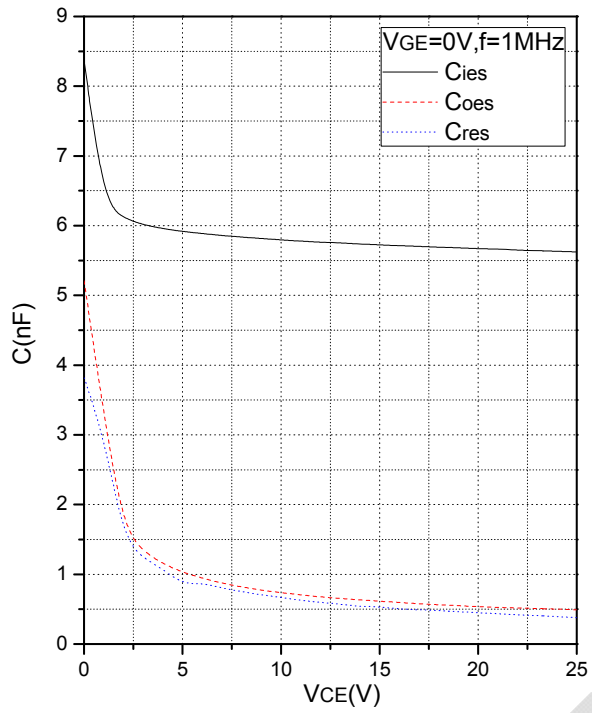
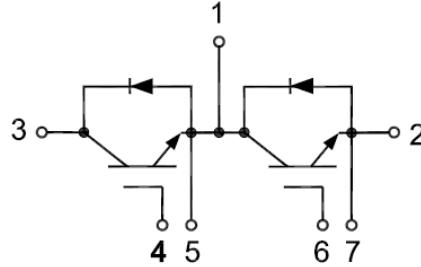

Fig.9 Capacitance Characteristics

SilverMicro

Internal Circuit



Package Outline (Unit: mm):

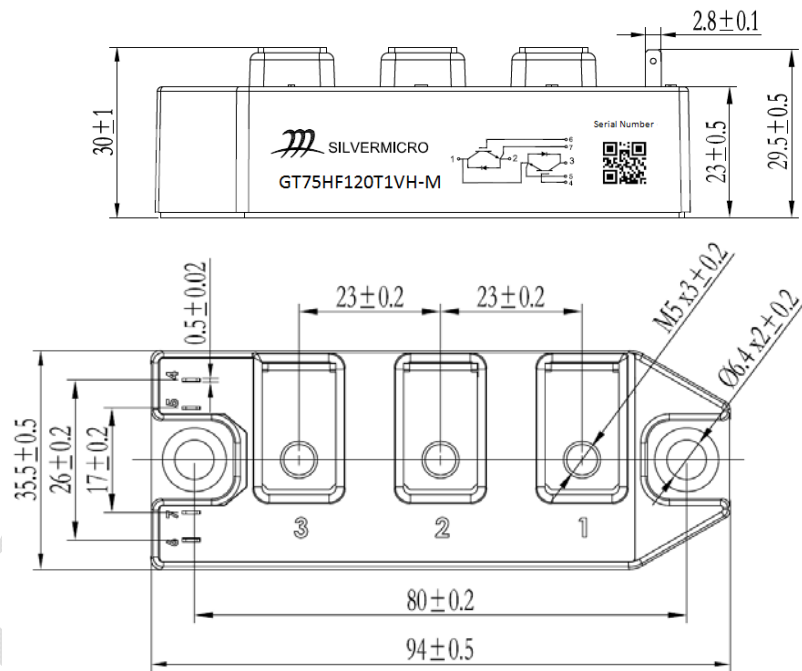



Announcements

Information in this document is believed to be accurate and reliable. However, NJSME does not give any representations or warranties, expressed or implied, as to the accuracy or completeness of such information and shall have no liability for the consequences of use of such information.

Right to Make Changes

NJSME reserves the right to make changes to information published in this document, including without limitation specifications and product descriptions, at any time and without notice. This document supersedes and replaces all information supplied prior to the publication hereof.

SilverMicro